

Test Your



Test Your



Professional English Business: General

Professional English Business: General

Test Your Professional English: Business General is one in a series of ten useful *Test Your Professional English* books. This thoroughly revised and updated edition features 60 clear and simple tests for business students and professionals who use English in their work. The book is organized into 8 sections and covers over 500 key words and expressions in areas such as marketing, finance, human resources, computing, meetings, presentations and business travel.

- 60 tests covering over 500 key words and expressions
- Wide variety of tests, including crosswords, cartoons, fill-the-gaps, and many more
- NEW – Tips on using English for business communication
- A-Z word list and full answer key
- Ideal for self-study and classroom use

Advanced	<input type="checkbox"/>	Adults	<input type="checkbox"/>
Upper Intermediate	<input type="checkbox"/>	16+	<input type="checkbox"/>
Intermediate	<input type="checkbox"/>	12-15	<input type="checkbox"/>
Pre-intermediate	<input type="checkbox"/>	Primary	<input type="checkbox"/>
Elementary	<input type="checkbox"/>		
Beginner	<input type="checkbox"/>		

Cover designed by
Ten Toes Design

Cover photography by
Z & B Baran

Also look out for:



ISBN 0-582-45148-5



9 780582 451483

STEVE FLINDERS TEST YOUR PROFESSIONAL ENGLISH BUSINESS: GENERAL

ISBN 0582 451

429



Published and distributed by
Pearson Education Limited

Pearson Education Limited
Edinburgh Gate
Harlow

Essex CM20 2JE, England
and Associated Companies throughout the world.

ISBN 0 582 45148 5

First published 1996 as *Test Your Business English Elementary*
This edition published 2002

Second impression, 2003

Text copyright © Steve Flinders 1996, 2002

Designed and typeset by Pantek Arts Ltd, Maidstone, Kent
Text Your format devised by Peter Watcyn-Jones
Illustrations by Roger Fereday and Anthony Seldon
Printed in China
SWTC/02

All rights reserved; no part of this publication may be reproduced, stored in a retrieval system, or transmitted in any form or by any means, electronic, mechanical, photocopying, recording or otherwise, without the prior written permission of the Publishers.

Acknowledgements

Many thanks to John Fagan and Bob Dignen at York Associates for their advice on the content of this edition, and to Mathieu and Jérôme Flinders for their help with the proofs.

Published by Pearson Education Limited in association with Penguin Books Ltd, both companies being subsidiaries of Pearson plc.

For a complete list of the titles available from Penguin English please visit our website at www.penguinenglish.com, or write to your local Pearson Education office or to: Penguin English Marketing Department, Pearson Education, Edinburgh Gate, Harlow, Essex CM20 2JE.

Contents

To the student	v	28	Business word families 1	41
Section 1: Business and you		29	Business word families 2	42
1 Your job	1	30	Business word building	44
2 Your company	2	31	Problem pairs	45
3 Your daily routine	3			
4 The people you talk to	4			
5 Your pay	6			
6 Your career	7			
7 Your computer	8			
8 Your office	10			
			Section 5: Business communication	
		32	Key phrases for business communication	47
		33	Internal communication	49
		34	Presentations	51
		35	Using visual aids	52
		36	Meetings 1	54
	12	37	Meetings 2	56
	14	38	Meetings 3	58
	16	39	Business trends	60
	18			
	19		Section 6: Business writing	
	20	40	Business documents 1	62
	22	41	Business documents 2	64
	24	42	Visuals in written communication	66
		43	Business letters	68
	26	44	E-mails	70
	28	45	Business forms	72
	29	46	The CV	73
	30			
	32		Section 7: Business functions	
	33	47	Business functions	74
	34	48	Finance	76
		49	Marketing	78
		50	Human resources	80
	35	51	Computing	82
	36	52	Production 1: in the factory	84
	38	53	Production 2: from factory to home	86
	40			
			Section 4: Business language	
	35	24	Business word pairs	35
	36	25	Basic business words	36
	38	26	Business idioms	38
	40	27	Business verbs	40
			Section 3: The business manager	
	26	17	The business bag	26
	28	18	Business travel	28
	29	19	Communications	29
	30	20	Number crunching	30
	32	21	Describing people 1	32
	33	22	Describing people 2	33
	34	23	Describing people 3	34
			Section 2: Business organization	
	12	9	A visit to a business	12
	14	10	Places	14
	16	11	Jobs	16
	18	12	Grades	18
	19	13	The organization chart	19
	20	14	Departments	20
	22	15	Locations	22
	24	16	Ownership	24

Section 8: General business

54 Business and the environment	87
55 Women in business	88
56 Business and the economy	90
57 Outsourcing	92
58 Business initials and abbreviations	94
59 From first to last	95
60 Your USP	96

Answers

97

Word list

103

To the student

Do you work in business and use English in your job? Or are you a business student? Whatever your background, if you need to improve your business English, the tests in this book will help. They will check your knowledge of basic business words and essential business expressions so that you can understand and communicate more effectively and confidently.

There are eight sections in the book. The first section tests your ability to talk about yourself and your role: to say who you are and what you do. The other seven sections each cover a different area of business – from organization and different areas of business-to-business language and communication. You can work through the book from beginning to end, or you can work first on the tests which are most important to you.

Many tests also have tips (advice) on language and language learning, and information about business. Do read these explanations and tips: they are there to help you.

To make the book more challenging and more fun, many different kinds of test are used, including gap-filling, word families, multiple choice and crosswords. There is a key at the back of the book so that you can check your answers; and a word list to help you revise key vocabulary.

Your vocabulary is an essential resource for effective communication. It is important to remember that the more words you know, the more you can say and the more you can understand. These tests can help you check what you know and develop your knowledge of new concepts and terms in a structured and systematic way. This book can help you significantly increase your business vocabulary.

Steve Flinders

1 Your job

The full series consists of:

- Test Your Professional English: Accounting
- Test Your Professional English: Business General
- Test Your Professional English: Business Intermediate
- Test Your Professional English: Finance
- Test Your Professional English: Hotel and Catering
- Test Your Professional English: Law
- Test Your Professional English: Management
- Test Your Professional English: Marketing
- Test Your Professional English: Medical
- Test Your Professional English: Secretarial

- Alison Pohl
- Steve Flinders
- Steve Flinders
- Simon Sweeney
- Alison Pohl
- Nick Brieger
- Simon Sweeney
- Simon Sweeney
- Alison Pohl
- Alison Pohl

Complete each of the following sentences with *in*, *on* or *for*. There are two possible answers for number 2. You can then make similar sentences about yourself and your job.

- 1 Olga Blanc is in computers.
- 2 She has been working for a big computer company for five years.
- 3 She is based in Paris.
- 4 She works in the external communications department.
- 5 At the moment she is working on the design of the company's website.
- 6 She is responsible for the development of an important part of the site.
- 7 She is very interested in Website design.
- 8 She depends on the web and on personal contacts for new ideas.
- 9 She spends one or two hours every day on the Web getting information about all the latest developments.
- 10 She is happy because there is a big demand for good website designers at the moment.



Tenses at work

- You use the present simple to talk, for example, about where you work or what you do: *I work ...*
- You use the present continuous to talk about current projects: *I am working ...*
- External communications** means how the company communicates with the outside world. **Internal communications** means how people inside the company communicate with each other.

2 Your company

Fill in the missing words in the sentences below. Choose from the words in the box. You can then use similar sentences to talk about your company.

company competitors customers employees leader products
profit share shareholders share price subsidiaries turnover

- 1 I work for a company called Kwikshoe.
- 2 Our main _____ are sports shoes.
- 3 Kwikshoe is a world _____ in the tennis shoe sector.
- 4 It has a national market _____ of 23%.
- 5 It has 2,500 _____ in this country.
- 6 It has seven _____ in five different countries.
- 7 Its main _____ are young people and people who do sport.
- 8 Its main _____ are in Britain and the USA.
- 9 Its main _____ are banks and pension funds.
- 10 Its _____ last year was \$1.2 billion.
- 11 Its _____ last year was \$16 million.
- 12 Its _____ today is \$57.



If you are the number one in a market, sector or region, you can say:

We are *the leader* in the ... sector ...

We are *the biggest* ... in the market.













If you are the number two or three, you can say:

We are *a leader* in the provision of ...

We are *the second / third / fourth biggest* ... in the region.

3 Your daily routine

Lorenza Müller is telling her partner about her day at the office. Match the beginning of each sentence on the left (1–13) with a phrase on the right (a–m). You can then make similar sentences to talk about your day at work.

- | | | | |
|----|--|---|---|
| 1 |  I looked at _____ | a | the monthly figures to Mr Kazoulis. |
| 2 |  I wrote _____ | b | an appointment with a client. |
| 3 |  I made _____ | c | the minutes of the meeting. |
| 4 |  I went to _____ | d | a representative of the safety committee. |
| 5 |  I took _____ | e | the company magazine. |
| 6 |  I fixed _____ | f | three or four replies. |
| 7 |  I met _____ | g | two or three telephone calls. |
| 8 |  I had _____ | h | the office Christmas party with Cynthia. |
| 9 |  I read _____ | i | a \$10 million deal. |
| 10 |  I discussed _____ | j | my e-mails. |
| 11 |  I presented _____ | k | lunch with Tom in Accounts. |
| 12 |  I negotiated _____ | l | tired but happy. |
| 13 |  I came home _____ | m | the weekly departmental meeting. |

4 The people you talk to

Choose one word or phrase from the box to complete each sentence.

boss Chief Executive Officer colleague customer
 director investor leader manager opposite number
 owner shareholder supplier

My name's John Power. Power Enterprises belongs to me. I'm the (1) **owner**. I also manage the company myself. I'm the (2) _____.

I'm John Power's sister. I sit on the Board of his company. I'm a (3) _____.

I'm Mr Power's secretary.
 He's my (4) _____.

I hold equity in this company.
 I am a (5) _____.

John Power is a friend of mine. I have put some of my own money into Power Enterprises. I'm an (6) _____.

I buy things from this company.
 I'm a (7) _____.

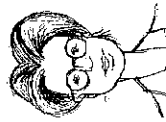
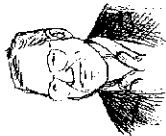

This company buys things from me.
 I'm a (8) _____.

I'm the head of a team in the technical department.
 I'm a team (9) _____.

I have lunch every day with the woman at the desk next to mine. She is my (10) _____.

I'm the marketing director of Power Asia Pacific. Jim Poom is the marketing director of Power Europe.
 He's my (11) _____.

I work for Power Enterprises. I head a department of about 50 people. I'm a (12) _____.

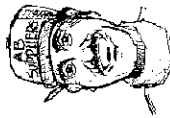

There is not a big difference between **customers** and **clients** and sometimes both can be used. In general, people in shops are usually customers, while businesses and professional people like lawyers and accountants have clients.

Boss is an informal word, not something you will see on an organization chart. The terms **superior** and **subordinate** were once used to talk about people above and below you in the organization, but they are less common today.

5 Your pay

You have just agreed your pay with the Board. Fill in the missing words in the sentences below.

benefits bonus car expenses health insurance income
pension rise salary stock option vouchers

- 1 Your base salary will be \$500,000 per year.
- 2 When you are 65, you will get a _____ of \$400,000 per year.
- 3 But you will get many other _____ as well.
- 4 A _____ plan gives you shares in the company which you can sell at a profit if the price goes up.
- 5 You have an expensive company _____.
- 6 You have unlimited travel and entertainment _____.
- 7 You get free _____.
- 8 You get free luncheon _____ which you can use in most restaurants in the city.
- 9 And you get a special _____ if the company's sales go up by more than 15% in the year.
- 10 So your total _____ next year could be more than a million pounds. Even so, you are thinking about asking for another _____ soon!

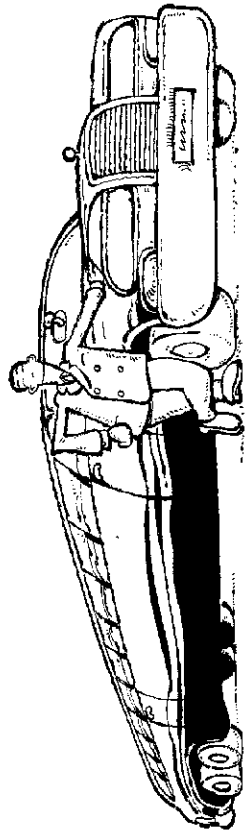

One of the benefits...

6 Your career

Tony Johansen tells us about his professional life but some of the letters are missing from the key words. Fill in the missing letters. Take care with the correct form of the verb. You can then make similar sentences about your own professional life story.

- 1 I guess my C A R E E R so far has not been very typical.
- 2 My first J _____ was with Flat Earth Mechanics.
- 3 I S _____ T _____ with them in 1975.
- 4 It was just after I had L _____ F _____ school.
- 5 My first job was in the office but I soon M _____ V _____ to the sales department. I knew then that I was born to be a salesman!
- 6 In 1980 I was P _____ O _____ E _____ to the position of sales manager.
- 7 But soon after that, the company went through a bad period and most of us were M _____ D _____ R _____ D _____ N _____ A _____ T.
- 8 It took me two weeks to find another job and at the beginning of 1981 I J _____ I _____ E _____ Round Earth Mechanics.
- 9 This was a much more successful company and in 1990 I was A _____ P _____ I _____ T _____ to the post of national sales manager.
- 10 Things have been fine since then although I was almost F _____ R _____ once for paying my sales people too much commission.
- 11 I have no plans to R _____ T _____ R _____ before I'm 60.
- 12 If someone O _____ F _____ R _____ me a better job, I will think about it seriously!

7 Your computer

Match the parts of the computer (a-k) with the following terms (1-11).

- 1 keyboard k
- 2 screen
- 3 CD-ROM drive
- 4 printer
- 5 mouse
- 6 disk drive
- 7 disk
- 8 monitor
- 9 scanner
- 10 loudspeakers
- 11 web camera

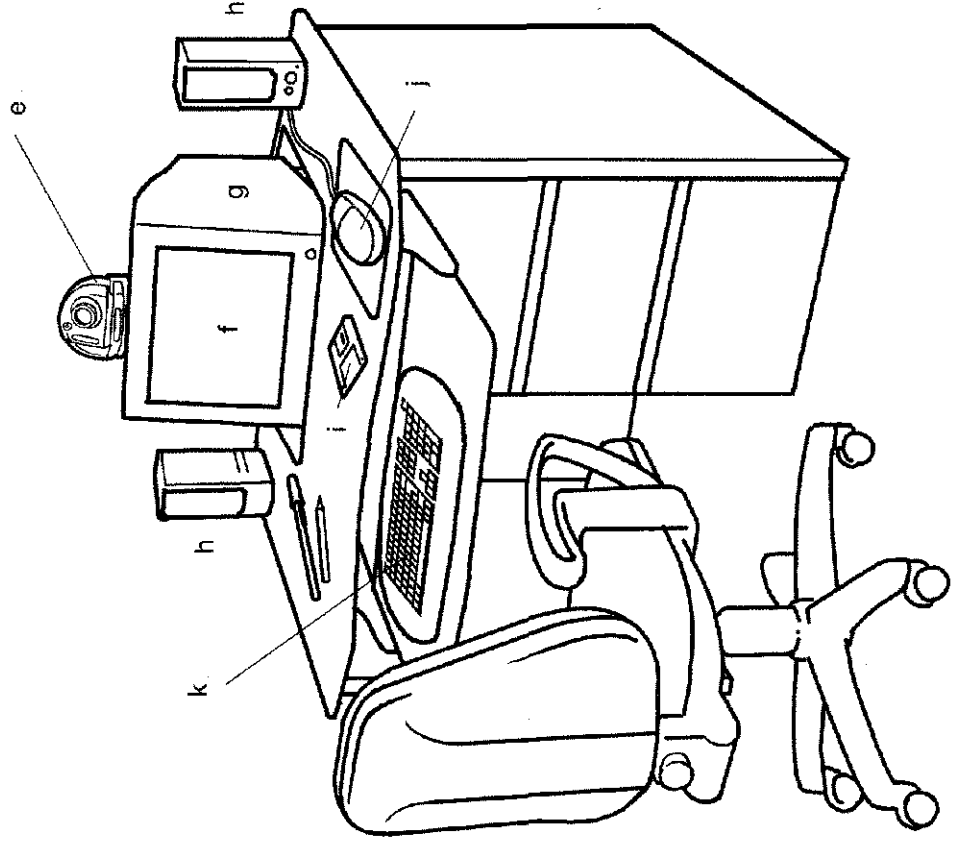
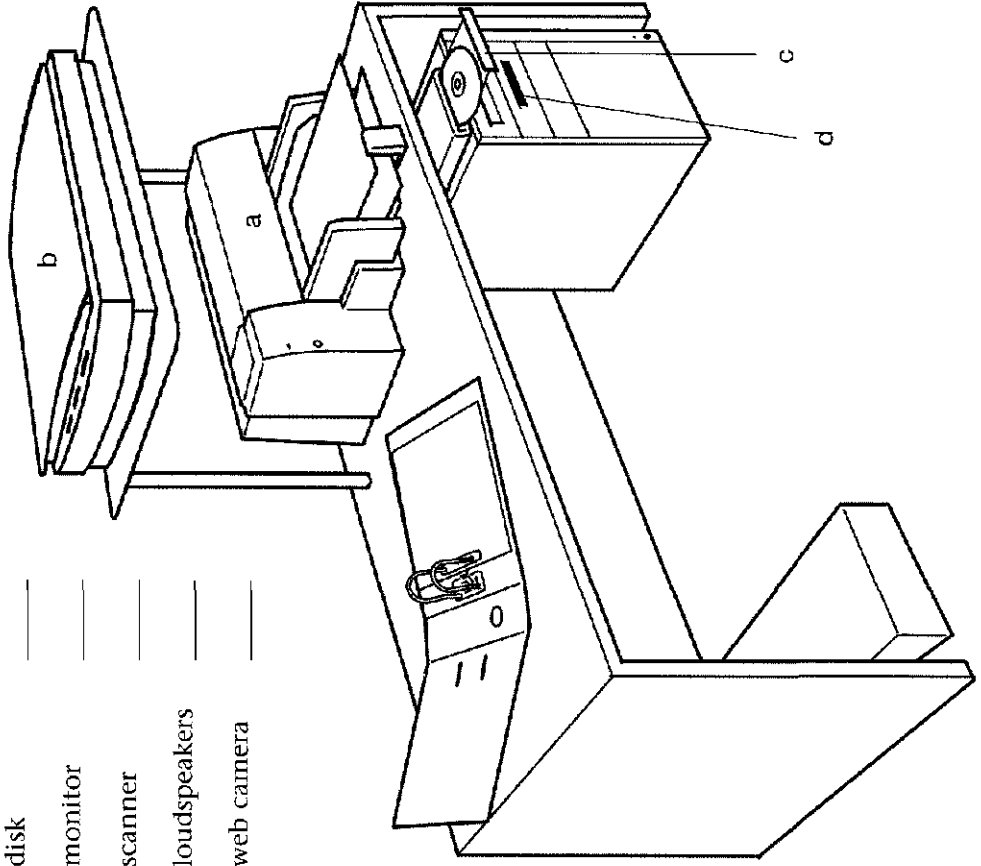

8 Your office

What do you keep on your desk and in your office? Match the items (a-o) with the correct terms (1-15).

- 1 ring binder _____
- 2 envelopes _____
- 3 plastic sleeves _____
- 4 Post-its _____
- 5 scissors _____
- 6 headed paper _____
- 7 waste paper bin _____
- 8 stapler _____
- 9 staples _____
- 10 in-tray _____
- 11 filing cabinet _____
- 12 hanging file _____
- 13 paper clips _____
- 14 ruler _____
- 15 hole punch _____

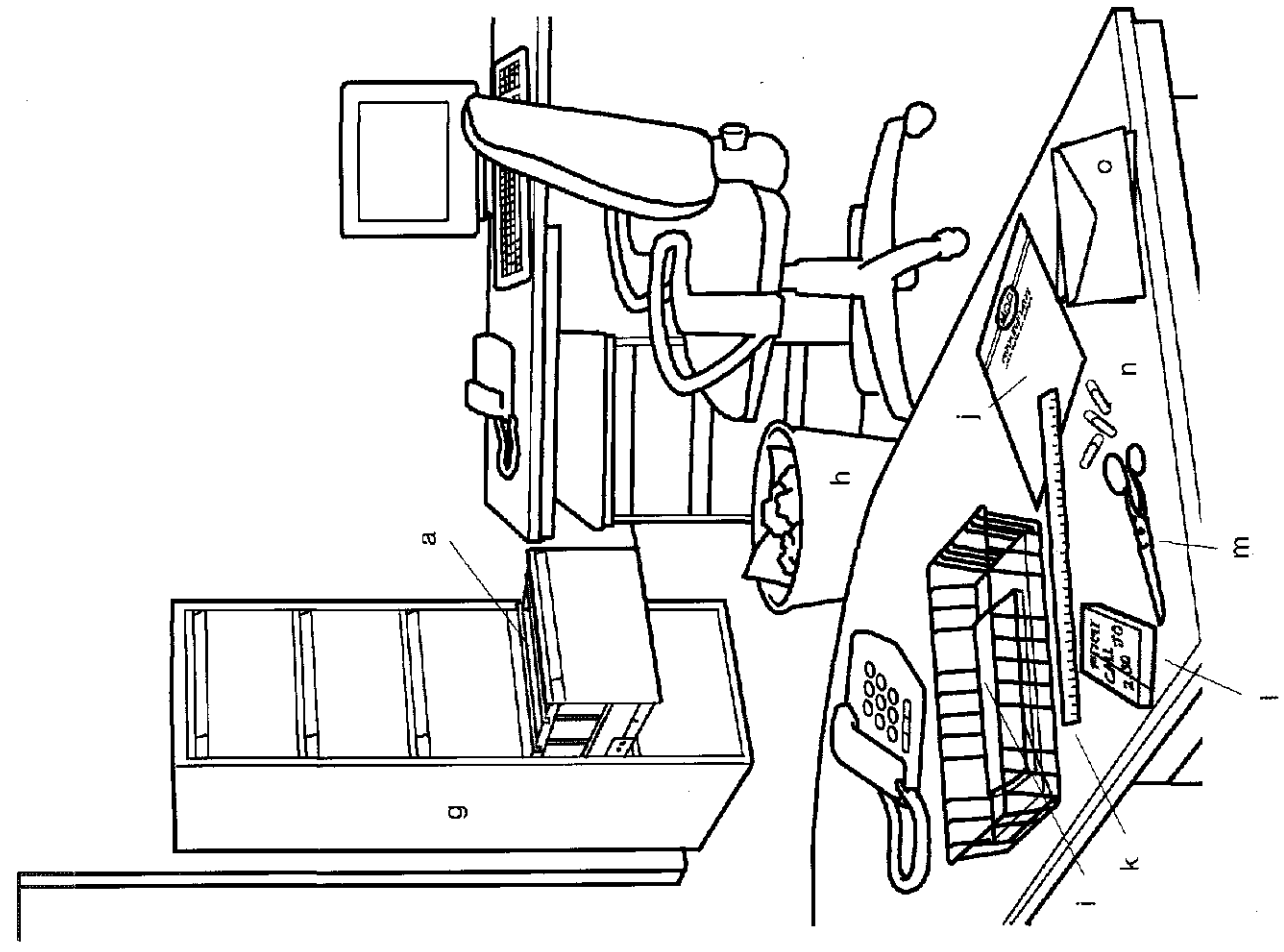
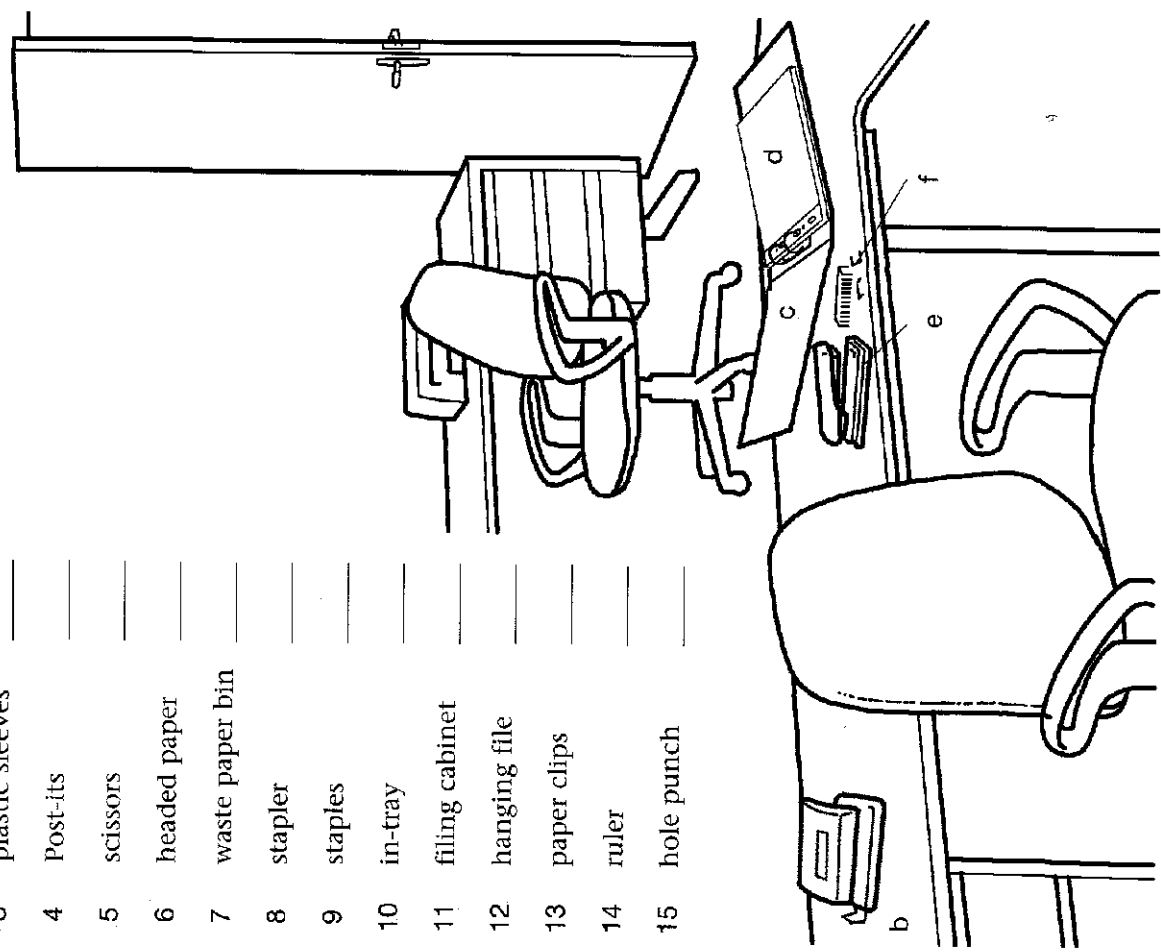

9 A visit to a business

Fill in the missing words or phrases in the sentences below. Use the pictures to help you. Choose from the words in the box. (When you have finished, you can say what visitors have to do to reach you.)

appointment badge deal floor identity card
lift main building main-gate office reception desk
receptionist secretary security guard sign

1

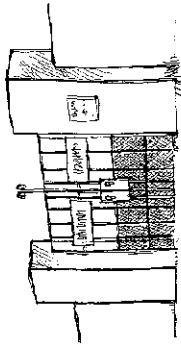

You arrive at the
main gate.

2

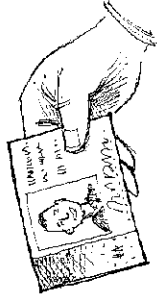

You show your
_____.

3

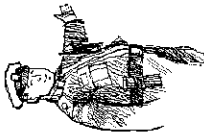

The
_____ lets you go through.

4

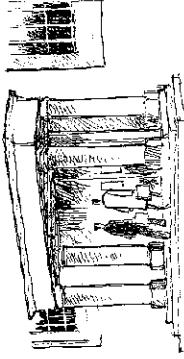

You enter the
_____.

5

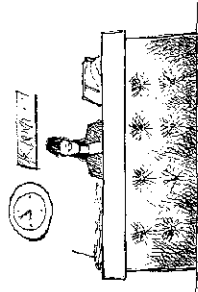

You walk to the
_____.

6

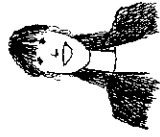

You give your name to
the _____.

7

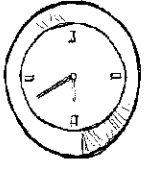

You have an

with Mr Power at 9.

9

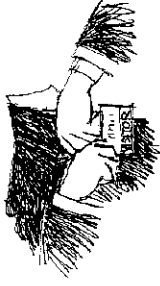

You pin your

to your coat.

11

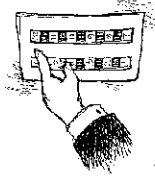

You go to the top
_____.

12

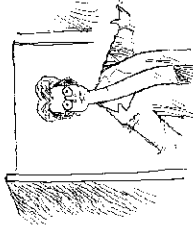

Mr Power's

meets you.

13



She takes you to Mr Power's
_____.

14

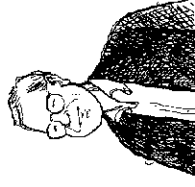

Mr Power says, 'Hi, we
have a _____.'



British English speakers take the **lift**.

American English speakers take the **elevator**.

10 Places

Match the places (a-k) with the correct business locations (1-11).

- | | | | |
|---------------------|-------|---------------------|-------|
| 1. call centre | b | 7. research lab | _____ |
| 2. factory | _____ | 8. showroom | _____ |
| 3. meeting room | _____ | 9. trade fair | _____ |
| 4. office | _____ | 10. training centre | _____ |
| 5. open-plan office | _____ | 11. warehouse | _____ |
| 6. reception | _____ | | |

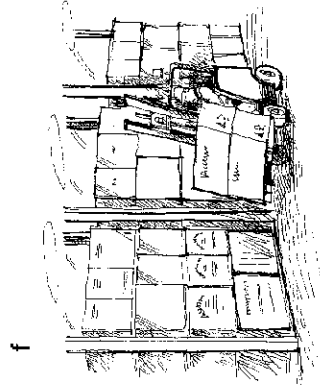
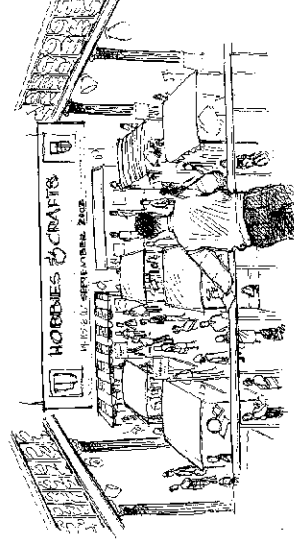
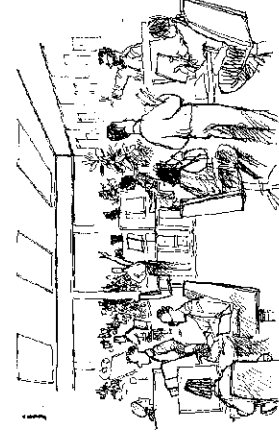
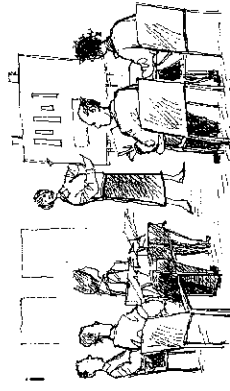
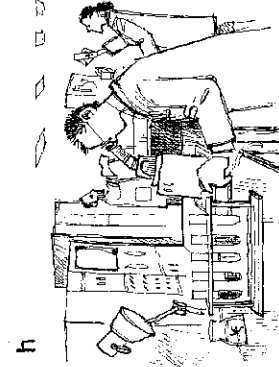
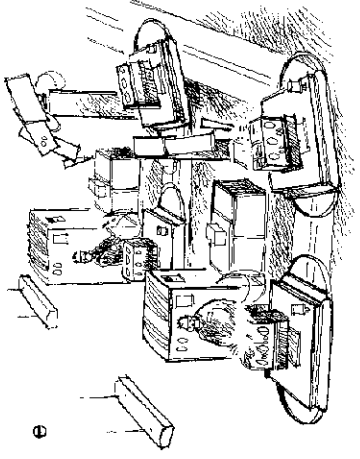
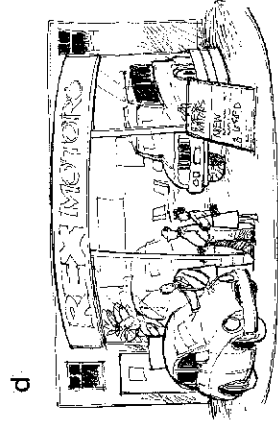
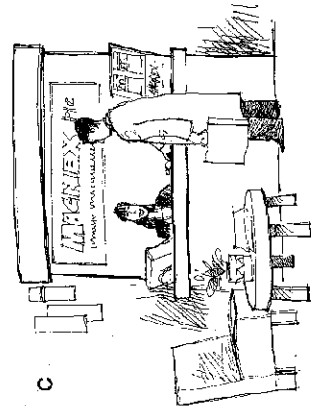
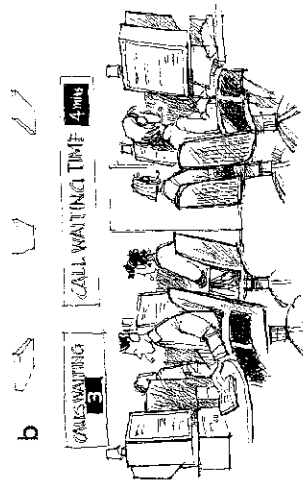
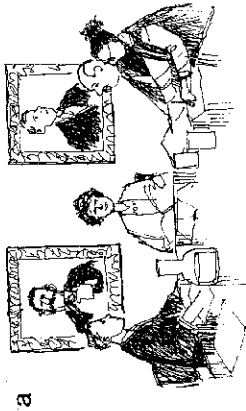

11 Jobs

Match the business cards (a–f) with the job descriptions (1–12).

- 1 I buy all the things that the company needs. **f**
- 2 My job is to make sure that the company has a good image.
- 3 My job is to find and test new products.
- 4 I'm in charge of the people who sell our products.
- 5 I type letters, file papers and make appointments for my boss.
- 6 I have general responsibility for the whole company.

John Sutton
Managing Director

Linda Gabbadini
Human Resources Director

Dietrich Hofmeister
Finance Director

Alice Hernandez
Chief Accountant

Li Wan
Secretary

LENA JOHANSSON
PURCHASING MANAGER

- 7 I make sure we have the products which people want to buy. **g**
- 8 I look after the company's money. **h**
- 9 I do the books and prepare the balance sheets. **i**
- 10 I'm the company's people manager. **j**
- 11 I make the products which the company sells. **k**
- 12 I'm responsible for everything when the boss is away. **l**

François Barbot

Assistant General Manager

YURI MANKOVICH
Director of Research
and Development

Jim Hicks
Production Manager

PADRIG BYRNE
MARKETING DIRECTOR

Santi Brunello
Sales Director

Kate Hogg
Public Relations Manager



In some cultures, people exchange **business cards** at the beginning of a meeting or a visit. In others, they do it at the end of the meeting. In some cultures, people present their business cards with one hand. In others, they present the card with two hands. In some cultures, business cards are usually white. In others, they can be multi-coloured.

What information do you have on your card? What colour is it? When do you give it to another person? Do you know people who do things differently?

12 Grades

Square Hole Engineering Inc. has four white-collar grades and four blue-collar grades. Write the names of all eight grades in the list, from the top (1) to the bottom (8).

clerical grades junior management middle management
 semi-skilled grades senior management skilled grades
 supervisory grades unskilled grades

White-collar grades

1	senior management
2	
3	
4	
5	
6	
7	
8	

Blue-collar grades



There are eight **layers** or **levels** in the organization chart of this company. A company with only a few levels has a **flat organization**. A company with a lot of levels is often very **hierarchical** because decisions have to travel through several layers.

White-collar workers often work in offices, banks, etc. They work in management or administration.

Blue-collar workers often work with their hands, for example on the production line in a factory.

13 The organization chart

Read this short presentation of the management team of this British company. Then write the correct letters (a–n) in the right places in the organization chart.

At the top of the company, the Chairman of the Board [a] is responsible to the shareholders and the day-to-day running is the responsibility of the Chief Executive Officer (CEO) [b], who also has a seat on the Board. Five directors form the senior management committee of the company. Going from left to right on the organization chart, we start with the Director of Finance [c], who runs his division with his Deputy [d].

Then we have the Director of Operations [e], who is responsible for production and logistics. The Factory Manager [f] answers directly to him.

Next we have the Director of Marketing [g], who is also responsible for sales so the National Sales Manager [h] reports to him on the activities of the whole sales team, which is divided into two regions, north and south, each managed by a regional sales manager [i; j].

The Director of Human Resources [k] has a Training and Development Manager [l] and a Compensation and Benefits Manager [m], who look after the day-to-day running of her department.

Finally, the Director of Research and Development [n] runs a small but important division of the company. She too reports directly to the CEO.

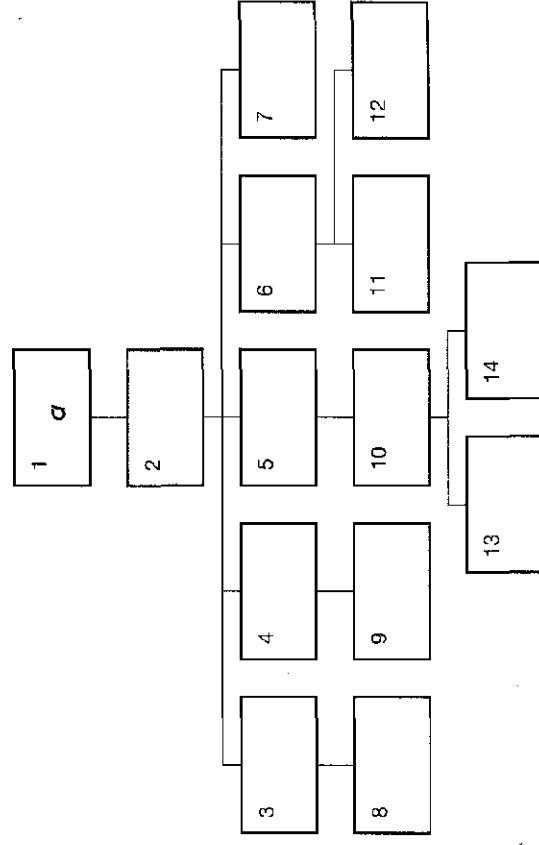

14 Departments

The organization is in trouble. Match the problems (a–l) with the correct departments (1–12).

- | | | | | | |
|---|------------------|-------|----|------------------------|-------|
| 1 | Distribution | e | 7 | Telephone After-sales | _____ |
| 2 | Personnel | _____ | 8 | Marketing | _____ |
| 3 | Research | _____ | 9 | Reception | _____ |
| 4 | Finance | _____ | 10 | Switchboard | _____ |
| 5 | Public Relations | _____ | 11 | Information Technology | _____ |
| 6 | Production | _____ | 12 | Quality | _____ |

a

One of the robots on the assembly line has stopped working.

b

Cash flow is much worse than I thought.

c

There's a national newspaper on the phone. They want to talk about water pollution near the factory.

d

There's something wrong with the network: all the screens have gone blank.

e

We have ten lorries waiting outside the main warehouse and there's nothing to put in them.

f

The unions have just asked for another 10%.

g

If we don't start producing some more useful ideas soon, they'll close down the laboratory.

h

Last month, there were problems with 0.31% of the bottles. This month I want that figure to be zero.

i

I'm very sorry, madam. We certainly asked the taxi to be here at three o'clock. I'll call them again immediately.

j

The latest survey shows that the majority of 18- to 25-year-old women think our perfume smells terrible.

k

I'm very sorry, sir. I've tried to reach his secretary several times but there's no reply.

l

If this doesn't work, I'll send an engineer to you this afternoon.



In **production and distribution**, modern manufacturing is becoming very complex. **Parts** can come into the factory from many different suppliers and **finished goods** then have to go to customers. Managing this process is called managing the **supply chain**.

Making products or providing services of good **quality** – that is, to a high standard – should be important for every company. Some companies have quality managers. But even if there is a quality manager, quality is everyone's responsibility.

People in **telephone after-sales** help callers who may have problems with products they have bought. For example, if you buy a computer and you don't understand how to make it work, someone in telephone after-sales will tell you what to do.

15 Locations

Ursula is telling her visitors about where the company is located. Fill in the spaces in the sentences below.

factories ~~head-office~~ local agents
local offices office plant regional headquarters
research and development centres training centres warehouses

Our (1) **head office** is in London. This is where most of our senior managers work. We also have four (2) _____ : in Singapore, serving Asia; in Boston, Massachusetts, serving the whole of North America; in Buenos Aires for South America; and in Zurich, for Europe, Africa and the Middle East. We have (3) _____ in seventeen other countries, and in countries where we do not have our own people we usually have (4) _____.

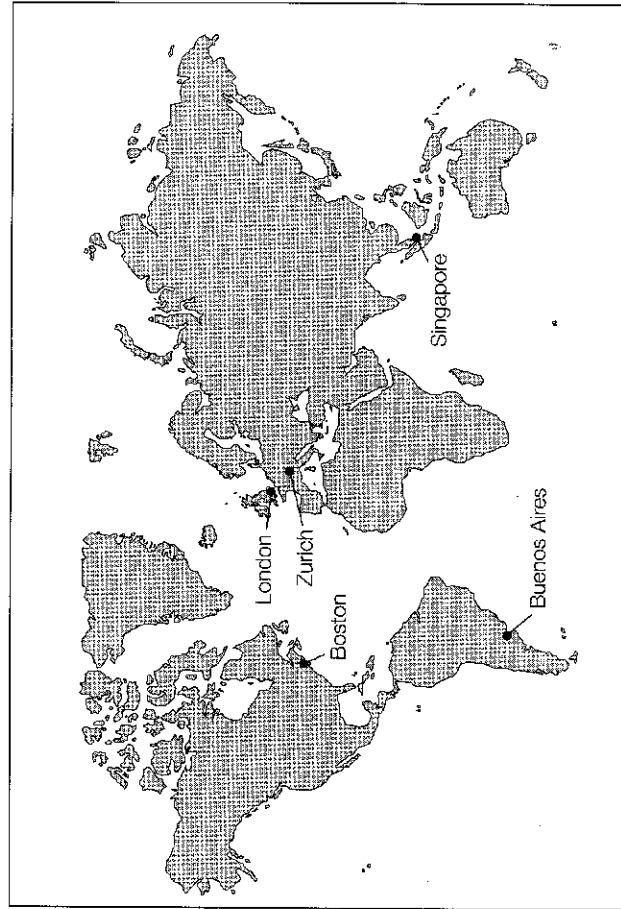

Of course, we make a wide range of products but recently we have closed some (5) _____ and reduced the number of products being made at others. However, distribution is still as local as possible and we have (6) _____, depots and distribution centres in almost every country in which we operate.

We have also closed some of the smaller (7) _____ and moved many of our best scientists and technicians to two major centres in France and the United States.

We think that staff development is essential to our present and future success and we run more than 5,000 courses for our employees in the fifty (8) _____ which we have across the world.

Well, that's all I want to say about our presence worldwide. Now, if you would like to follow me, first of all I'll show you my (9) _____ and then we'll start the tour of the (10) _____.



You can talk about your company's **head office** or your company's **headquarters**. But note that headquarters can be singular or plural: *Our headquarters is in Warsaw.* *Our headquarters are in Warsaw.*

16 Ownership

Fill in the missing words in the sentences below. Choose from the following:

- family-company hostile takeover joint venture merger
- parent company principal shareholders privatized stakeholders
- state-owned subsidiaries takeover

- 1 Rich & Bright was started by Sam Rich and his brother-in-law, Charlie Bright, fifty years ago. It was a successful family company.
- 2 But the Socialist Party won an election and the government nationalized the company. It was now managed by a government department. It was _____.
- 3 Then the Christian Democrats won an election. The new government sold R & B. It was _____.
- 4 But by this time both Sam and Charlie had died. The new owners were banks and pension funds. They were the _____.
- 5 Of course, many more people – managers, employees and their families, and clients – also had an interest in the success of the company. These were the _____.
- 6 The new management decided to turn some of the business units into separate companies. They became _____.
- 7 R & B kept a majority shareholding in all of them. It was the _____.
- 8 Then the American giant, Monsterbuck, suggested that the two companies work in partnership on a new product. They proposed a _____.

- 9 But everyone knew that Monsterbuck really wanted to buy R & B. Monsterbuck wanted a _____.
- 10 The R & B management did not want Monsterbuck to buy the company. But Monsterbuck offered the R & B shareholders lots of money and won control. It was a _____.
- 11 Now there is news that Monsterbuck and another American giant, Megadollar, will join together soon. It will be a very big _____.

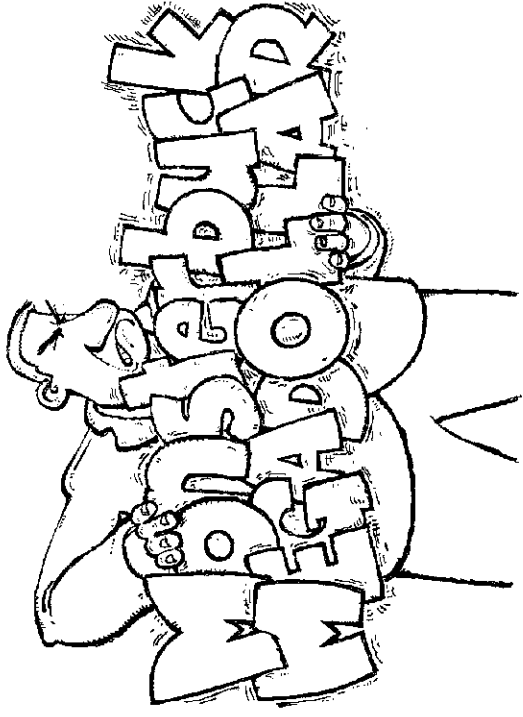

It will be very big!

17

The business bag

Empty a manager's bag and pockets or purse and what do you find? Match the pictures (a-k) with the correct terms (1-11).

- 1 tickets j
- 2 credit card _____
- 3 keys _____
- 4 mobile phone _____
- 5 cash _____
- 6 chequebook _____
- 7 passport _____
- 8 business card _____
- 9 wallet _____
- 10 personal organizer _____
- 11 adapter _____

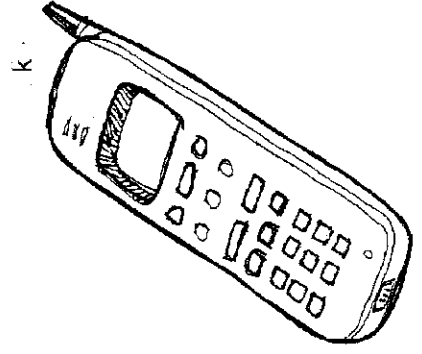
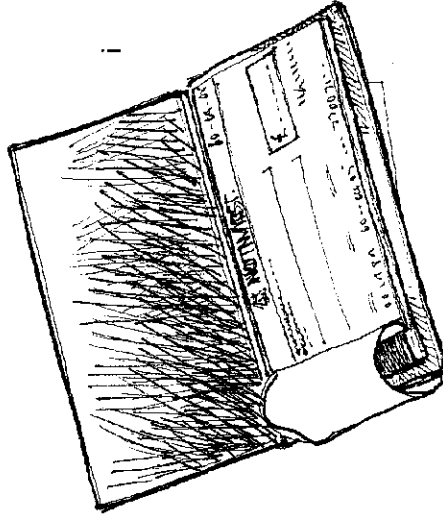
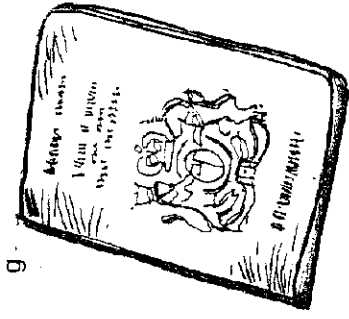
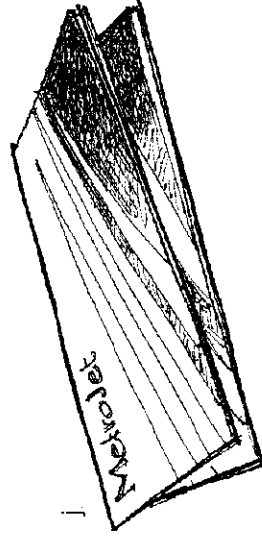
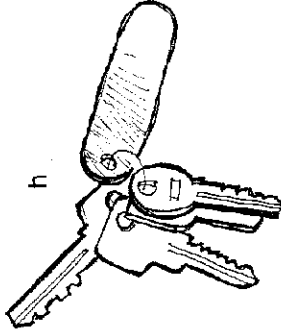
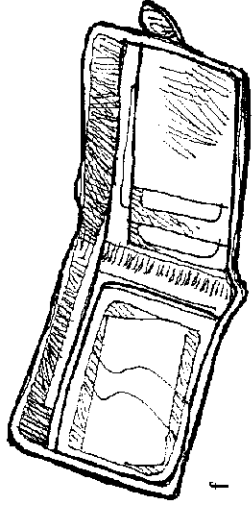
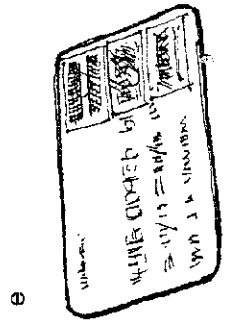
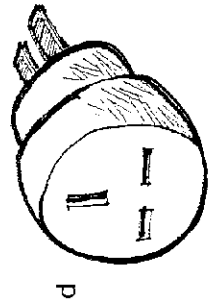
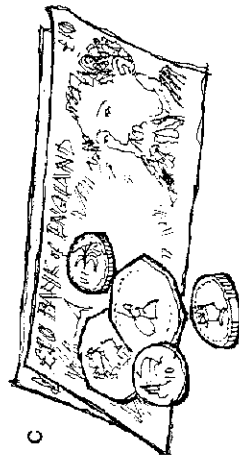
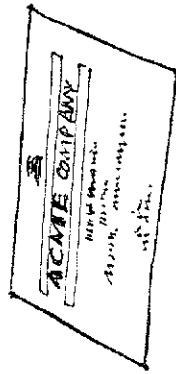
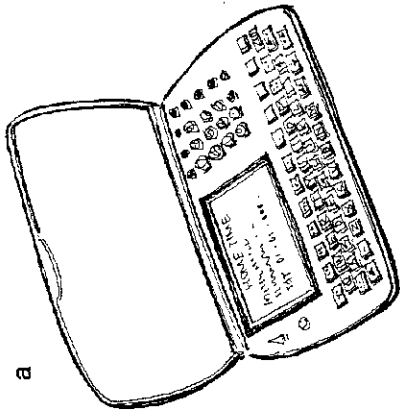

Cash is made up of coins, made of metal, which you keep in your pocket or in a purse; and notes, made of paper, which you keep in your wallet.

18 Business travel

Complete the sentences with words from the box.

aisle bill check-in desk connection excess baggage hand luggage
reservation room service seat belt single ~~tip~~ waiter

- The taxi driver took me the long way to the airport. I didn't give him a tip.
- I got to the _____ ten minutes before take-off. Fortunately the plane was late.
- I had a very heavy suitcase and two pieces of _____.
- The suitcase and one of the other bags were too heavy and I had to pay an _____ charge.
- I wanted a window seat but I could only get an _____ seat.
- The weather was bad and I had to wear my _____ all through the trip.
- The first plane arrived very late and so I missed my _____ another flight. I waited three hours in the airport for _____.
- At last I arrived at my hotel. They could not find my _____.
- I wanted a double room but I had to take a _____.
- I went to the hotel restaurant but could not find a _____ to serve me.
- I went back to my room and tried _____ but there was no reply.
- In the morning I asked for my _____. I don't need to tell you: they had got it wrong!

19 Communications

Find words in the word square which match these descriptions. The words may run from the top down, from the bottom up, from left to right or diagonally.

- It can weigh less than 200 grams and you can call your friends from almost anywhere with it. (6 and 5 letters)
- It bleeps to tell you there's a call. (5 letters)
- It connects computers round the world. (8 letters)
- You can go here for information in text, sound and pictures about an organization or an individual. (7 letters)
- The way for your company to buy and sell its products and services via computer. (9 letters)
- A message you send from one computer to another. (5 letters)
- A computer which you can carry with you when you travel. (6 letters)
- A computer which you can put in your pocket. (7 letters)
- A virtual company. (6 letters)

M	A	D	O	T	C	O	M	I	N	G	I	N	H	E	R
K	T	U	Y	O	P	N	D	S	X	A	Q	R	J	K	L
E	I	P	S	Q	T	A	B	U	L	A	P	A	G	E	R
I	A	N	A	T	R	R	S	P	Z	A	N	T	I	C	A
W	V	O	L	L	U	M	F	B	I	R	P	E	Y	W	M
Q	O	R	F	U	M	P	S	W	G	E	R	T	Y	U	O
I	J	O	P	E	S	T	D	F	D	G	H	J	O	K	B
L	H	Z	N	C	M	W	O	R	U	D	R	Z	E	P	I
K	E	L	P	O	G	H	J	P	D	S	U	T	R	W	L
U	M	Q	U	M	S	X	D	W	F	C	R	A	Y	J	E
G	A	V	D	M	A	I	N	T	E	R	N	E	T	H	P
J	I	D	L	E	F	G	T	H	R	O	V	F	R	E	H
B	L	N	B	R	X	C	W	E	B	S	I	T	E	W	O
D	E	G	T	C	N	Y	U	R	S	E	T	R	D	A	N
O	L	Q	W	E	X	H	K	N	W	E	G	V	R	W	E

Number crunching

Look at the spoken numbers in the box. Decide which sentence each number fits into, and then write the same number in figures in the sentence.

fifty-five	three-quarters
half seven	twenty-fifth
nought point nought three	twenty-three hundred
one quarter	two
seven thirty	two thousand and two
three double four oh four five six two	zero

- 1 Pay day for our salaried employees is on the 25th of every month.
- 2 We do a major strategic review every two or three years. The last one was at the beginning of _____.
- 3 Jimmy has saved a lot of money. He plans to retire when he's _____.

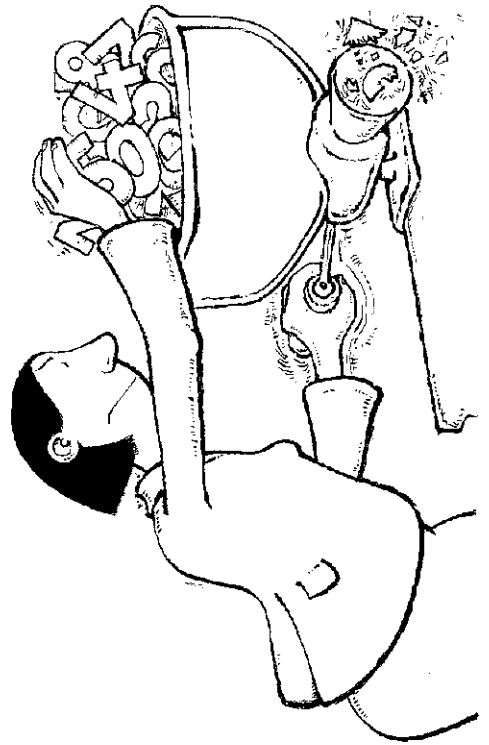

A lot of managers have to crunch numbers.

- 4 He also has a good pension scheme. It should give him about _____ of his salary after he retires.
- 5 We've reduced the percentage of damaged goods to _____ per cent of production.
- 6 We hope to achieve a level of _____ defects soon.
- 7 The timetable says that Charlotte's plane should arrive at _____ hours.
- 8 This is _____. Can I help you?
- 9 The meeting will start at _____ in the morning precisely.
- 10 _____?! That's a bit early, isn't it?
- 11 Interest rates have gone up again – from 7¼% to 7½% – that is to say, by _____ of one per cent.
- 12 Sales increased by _____ per cent last year: this is a rather disappointing result.



A **number cruncher** is a person who or a machine which works with numbers and does a lot of calculations very quickly. A lot of managers have to crunch numbers.

If you don't know the exact number, you can say:

it's **about** 100.

it's **around** 100.

it's **roughly** 100.

it's **approximately** 100.

21 Describing people 1

Match the descriptions (a–m) with the personality adjectives (1–13).

- | | | |
|------------------|----------|--|
| 1 tidy | h | a works well, does not waste time |
| 2 shy | _____ | b wants to have a top job |
| 3 self-confident | _____ | c doesn't get angry when he or she has to wait |
| 4 reliable | _____ | d doesn't feel confident when talking to people he or she doesn't know |
| 5 patient | _____ | e trustworthy, dependable |
| 6 demanding | _____ | f thinks carefully before doing or deciding anything |
| 7 nervous | _____ | g arrives on time |
| 8 ambitious | _____ | h keeps desk, papers, files, etc. in good order |
| 9 relaxed | _____ | i calm, unstressed, unworried |
| 10 cautious | _____ | j has a positive feeling about him or herself |
| 11 dynamic | _____ | k makes other people work hard, often to a high standard |
| 12 efficient | _____ | l afraid, does not have a lot of confidence |
| 13 punctual | _____ | m energetic and (usually) successful |



An **appraisal** is a description of your performance at work. Many people have **appraisal interviews** with their bosses one or more times per year to discuss the work they did in the last year and the work they will do next year. More and more **job interviews** and appraisal interviews are done in English.

22 Describing people 2

These pairs of words describe employee qualities and performance. From the words on the right, choose a synonym for each adjective (1–12).

- | | | | |
|------------------|-------|-------------|--------------|
| 1 tidy | _____ | <i>neat</i> | clever |
| 2 friendly | _____ | _____ | timid |
| 3 careful | _____ | _____ | easy-going |
| 4 intelligent | _____ | _____ | acceptable |
| 5 shy | _____ | _____ | self-assured |
| 6 reliable | _____ | _____ | cautious |
| 7 relaxed | _____ | _____ | adaptable |
| 8 self-confident | _____ | _____ | neat |
| 9 flexible | _____ | _____ | consistent |
| 10 systematic | _____ | _____ | outstanding |
| 11 satisfactory | _____ | _____ | dependable |
| 12 excellent | _____ | _____ | warm |

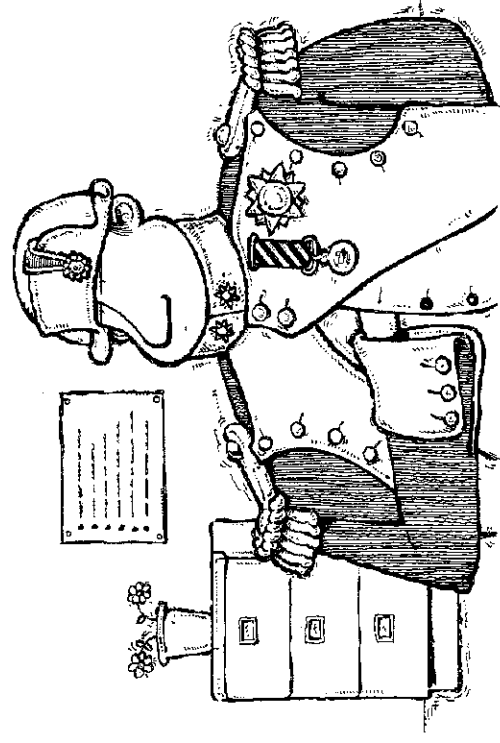

André is a very self-confident manager.

23 Describing people 3

Write the negative forms of the following adjectives using the prefixes un- (11 examples), in- (7 examples), dis- (3 examples), ir- (1 example) or im- (1 example).

Adjective	Negative	Adjective	Negative
1 tidy	untidy	13 obedient	
2 organized		14 reliable	
3 accurate		15 predictable	
4 systematic		16 friendly	
5 sensitive		17 diplomatic	
6 patient		18 trustworthy	
7 conventional		19 tolerant	
8 traditional		20 sincere	
9 convincing		21 orthodox	
10 responsible		22 honest	
11 efficient		23 experienced	
12 secure			

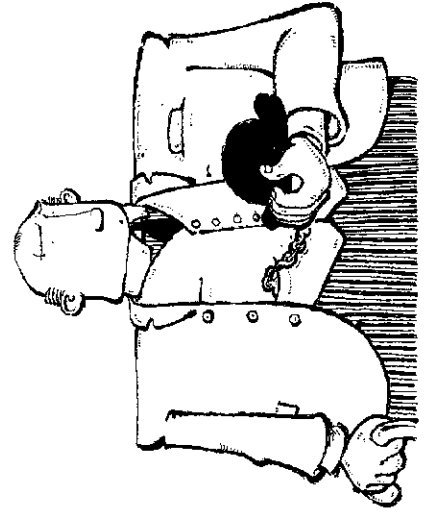

Herbert is a very traditional manager.

24 Business word pairs

Match the terms on the right (a-r) with their equivalents on the left (1-18).

1 headquarters	m	a chief
2 executive		b plan
3 human resources		c products
4 customer		d sales revenue
5 factory		e position
6 head		f purchaser
7 firm		g correspondence
8 manufacturing		h objective
9 Chief Executive Officer		i plant
10 turnover		j deliver
11 pay		k manager
12 buyer		l production
13 post		m head office
14 supply		n Managing Director
15 target		o company
16 letters		p salary
17 goods		q client
18 scheme		r personnel

25

Basic business words

Write one word in each mind map. Choose from the words and phrases in the box.

business customer executive financial management
~~market~~ price products profit staff

1 enter a new ~

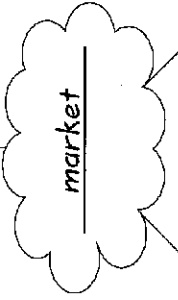

a ~ study a crowded ~

2

a high ~

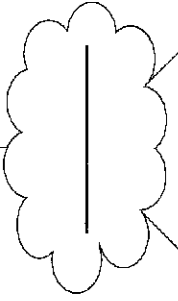

a bargain ~ a competitive ~

3

gross ~

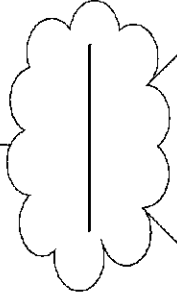

~ after tax a net ~

4 top-quality ~

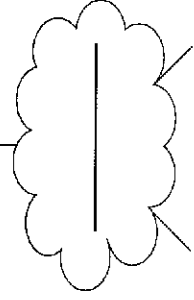

best-selling ~ a wide range of ~

5

a potential ~

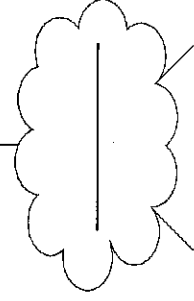

a ~ complaint an unhappy ~

6 ~ support

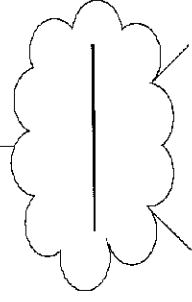

~ report ~ asset

7

well trained ~

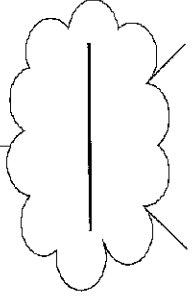

recruit more ~ polite and friendly ~

8

~ opportunities

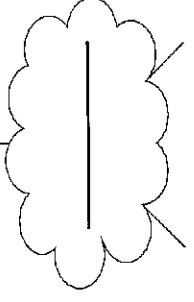

start a ~ a successful ~

9

financial ~

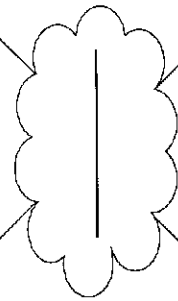

junior ~ middle ~

10

~ pay

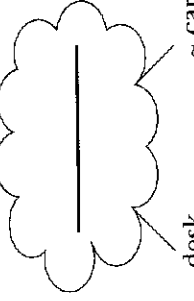

~ desk ~ car



Learning single words is not enough. Learning word families like these will help you build better sentences, understand better how individual words work and speak better English. Always look for word families when you read and listen to English.

People use **mind maps** as a learning tool, to remember vocabulary and to brainstorm ideas. In language learning, you can use a mind map to remember which words go together. Put one word (for example a verb: *manage*) in the central circle and then show other words (for example nouns: *project, team*) which often go with it. You can then add adjectives which go with the nouns (for example: *difficult, challenging*) and so on! People with visual memories find mind maps especially helpful.

26 Business idioms

Read the sad story of Pedro Brown. Then match the idioms (1–12) with their meanings (a–l).

- 1 Pedro Brown was on the ball. f
- 2 He had a good track record. _____
- 3 He had a good nose for a sale. _____
- 4 And he usually played his cards right. _____
- 5 But success went to his head. _____
- 6 He began to lose his touch. _____
- 7 He was always up to his eyes in work. _____
- 8 He started trying to pass the buck. _____
- 9 And then he put his foot in it. _____
- 10 The boss gave him a piece of his mind. _____
- 11 Nobody put him in the picture any more. _____
- 12 And in the end he was fired. _____

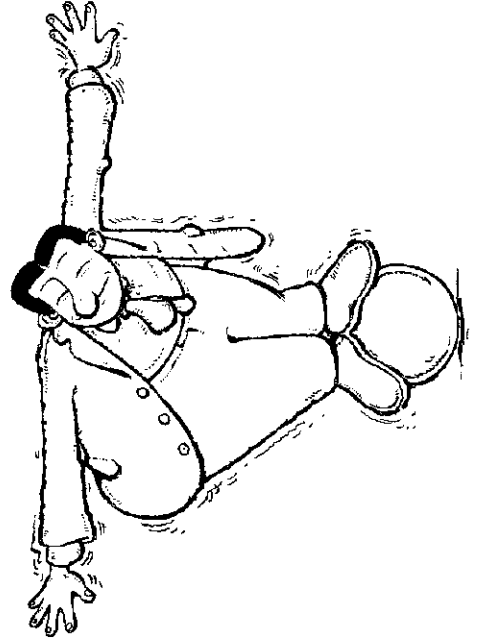

Pedro Brown was on the ball.

- a He began to have too important an opinion of himself.
- b He had too many things to do.
- c He made a big mistake.
- d He lost his job.
- e He was not told what was happening.
- f He was a clever employee, he knew what was going on.
- g He made the right decisions.
- h He passed responsibility to other people.
- i His job experience was good.
- j He talked to him very directly.
- k He started to make mistakes.
- l He was a natural salesman.

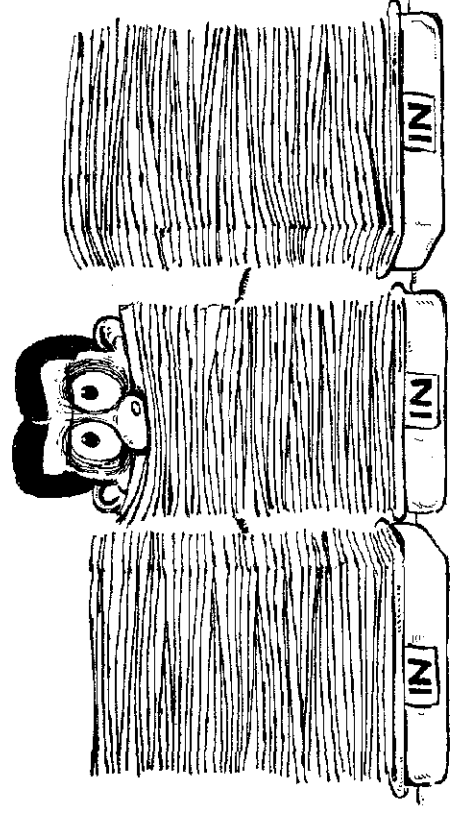

He was up to his eyes in work.

27

Business verbs

SECTION 4

The company is in crisis. Below is a memo from the Chief Executive Officer. Fill in the missing words in the sentences.

cut deal decide ~~fix~~ forecast launch make
play raise reach solve

We have to:

- 1 _____ *fix* _____ a meeting.
- 2 _____ with a very difficult situation.
- 3 _____ the problem of falling sales.
- 4 _____ agreement about exactly what to do.
- 5 _____ on a strategy.
- 6 _____ a profit next year.
- 7 _____ a new product very soon.
- 8 _____ next year's sales.
- 9 _____ the prices of our existing products.
- 10 _____ costs and staff.
- 11 _____ a different role in the market in order to survive.



You can also:
arrange a meeting, call a meeting or organize a meeting.

28

Business word families 1

SECTION 4

Circle the 'odd one out' in each of these groups of basic business words.

- 1 a) firm b) company c) enterprise **d) manager**
- 2 a) plant b) factory c) office d) works
- 3 a) sell b) make c) produce d) manufacture
- 4 a) client b) customer c) consumer d) employee
- 5 a) salary b) research c) pay d) income
- 6 a) manager b) profit c) executive d) business person
- 7 a) export b) division c) section d) department
- 8 a) assistant b) desk c) deputy d) subordinate
- 9 a) timetable b) plan c) schedule d) market
- 10 a) staff b) personnel c) product d) workforce
- 11 a) choice b) option c) action d) alternative
- 12 a) discuss b) call c) phone d) ring
- 13 a) aim b) target c) reach d) objective

Business word families 2

Write one word in each mind map. Choose from the following:

- accounting
- advertising
- communications
- computer
- financial
- market
- production
- quality
- research
- sales

1 newspaper ~ ~ campaign 2 ~ laboratory

TV and cinema ~ ~ agency

advertising

~ team ~ project

3 mainframe ~ ~ network

laptop ~ ~ programmer

4 ~ study

5 external ~ internal ~

~ research ~ survey

~ network good ~

6 creative ~

7 ~ capacity ~ processes

~ practices ~ calculations

~ methods ~ line

8 ~ circles ~ control

~ standards ~ assurance

9 ~ force ~ figures 10 ~ statements ~ markets

~ brochure ~ rep ~ assets ~ report



Creative accounting is when unusual but not illegal methods are used to make a set of accounts look better than they really are.

30

Business word building

SECTION 4

Fill in the missing words in the table.

	Verb	Person noun	General noun	Adjective
1	manage			managerial
2			analysis	
3				organizational
4				applicable
5				competitive
6		decision-maker		
7		investor		---
8			production	
9				regulatory
10	inform	---		
11	persuade	---		



Informant and **persuader** are English words but they are not much used in business.

An informant can be, for example, a police informant – someone who informs the police about the activities of people s/he knows.

Fifty years ago, Vance Packard, an American writer, wrote a book called *The Hidden Persuaders*, about the advertising industry.

Someone who makes decisions is not a decider but a **decision-maker**.

31 Problem pairs

SECTION 4

These pairs of words often cause problems. Choose the correct alternative for each sentence.

1 ECONOMIC / ECONOMICAL

- Prices are rising and the number of jobs is falling. It's not just a business problem, it's a general **economic** problem.
- This car uses less petrol than the other one so this one is the more **economical**.

2 TRAVEL / TRIP

- Zangief is doing too much business _____ and wants to cut the number of visits to foreign clients next year.
- However, he still has to make one important _____ to the agent in Singapore.

3 PRODUCTION / PRODUCTIVITY

- We will increase pay if the employees raise their _____.
- If we don't get another order soon, we'll have to cut _____ and maybe close a factory.

4 SALARY / WAGE

- We pay a monthly _____ by cheque to our white-collar staff.
- We pay a weekly _____ in cash to our part-time blue-collar staff.

5 EXPENSES / EXPENDITURE

- We have to reduce our general _____; we must cut costs wherever we can.
- The sales manager has to cut his travel, accommodation and entertainment _____; he'll have to stay in cheaper hotels and take his clients to cheaper restaurants.

6 PERSONNEL / PERSONAL

- a) Smith has a _____ problem: his wife wants to leave him.
- b) Smith's company has a _____ problem: their employees want a 20% pay increase.
- 7 INTERVIEWEE / INTERVIEWER
- a) The person who usually asks most of the questions at an interview is the _____.
- b) The person who usually answers most of the questions at an interview is the _____.
- 8 FOREIGNERS / STRANGERS
- a) Our company has been bought by a German multinational. More and more _____ are coming from abroad to work in our office.
- b) There were two _____ at the corner table in the restaurant where we usually go for lunch: no one had ever seen them before.

9 WHITE-COLLAR / BLUE-COLLAR

- a) _____ workers work in the factory.
- b) _____ workers work in the office.

10 ADVERTISING / ADVERTISEMENT

- a) Our _____ budget is 10% less than last year.
- b) Did you see the big _____ for a new Managing Director for Acme in this morning's newspapers?

11 LINE / STAFF

- a) A _____ manager works directly on the production of goods or the provision of services.
- b) A _____ manager gives support to the managers who produce the goods or provide the services.

12 RAISING / RISING

- a) Prices are _____ at a rate of about 4% per year.
- b) The company is _____ its prices by 5% this year.

32

Key phrases for business communication

Match the pictures (a-h) with the phrases (1-8).

- 1 Could you hold on, please? _____ a
- 2 Do you have any questions? _____
- 3 I'm very sorry, madam. _____
- 4 I'll make sure this doesn't happen again. _____
- 5 How are you? _____
- 6 I'm afraid that Mr Fangio is unavailable at the moment. _____
- 7 I've divided my subject into three parts. _____
- 8 Let me take your coats. _____
- 9 There are several points on today's agenda. _____

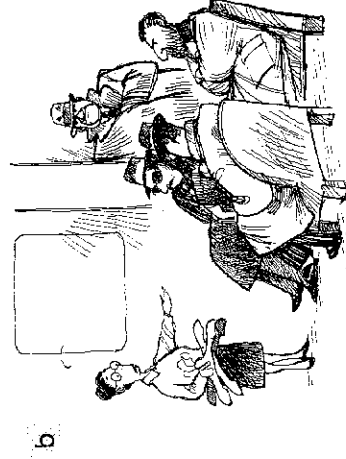

33 Internal communication

Business people communicate with each other in a number of different ways. Match the pictures (a-k) with the correct terms (1-11).

- 1 e-mail b
- 2 phone
- 3 letter
- 4 fax
- 5 video conference
- 6 notice board
- 7 office gossip
- 8 face to face
- 9 intranet
- 10 meeting
- 11 in-house magazine

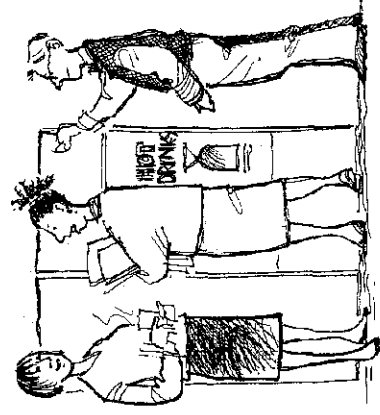
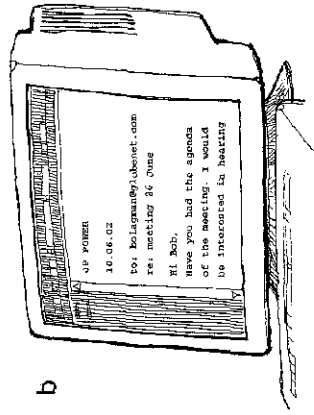
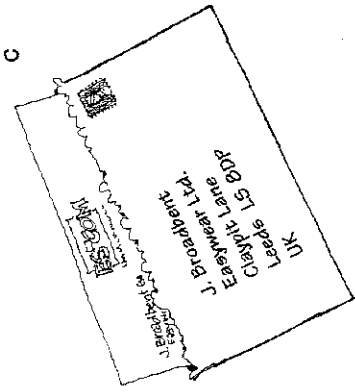
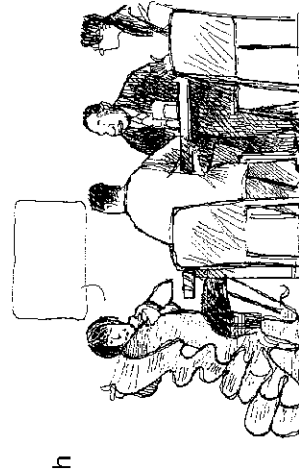
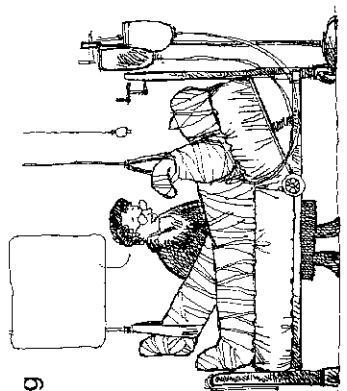
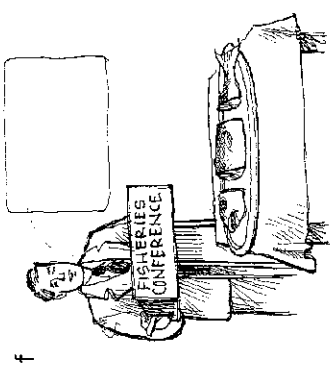
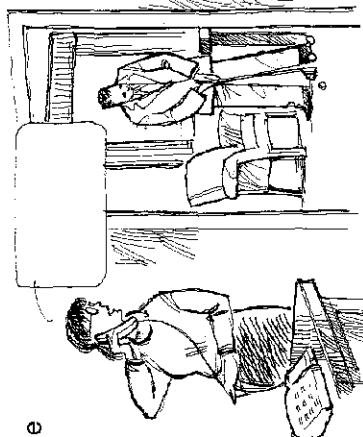
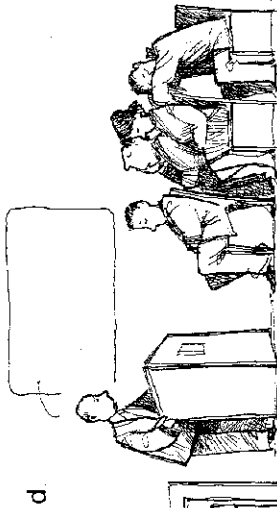

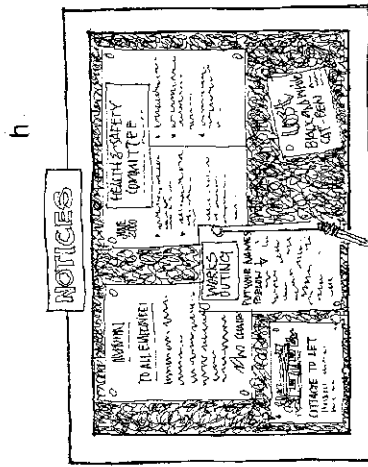
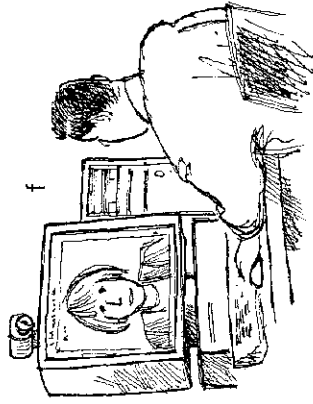
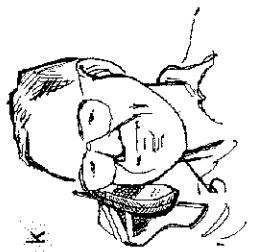
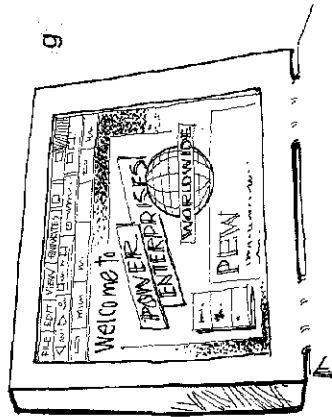
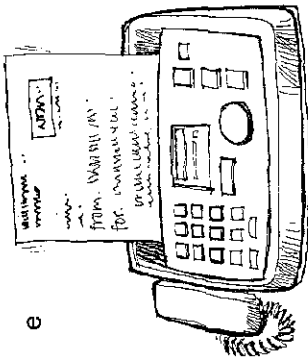

34 Presentations

Suzi Capra wants to make a good start to her presentation, so she has made a list of the things she wants to say. Unfortunately she has dropped all her language cards (a-j) on the floor. Help her to put them in the right order by matching them with the cues (1-10).

Cues

- 1 THANK audience for coming. c
- 2 INTRODUCE myself. _____
- 3 Give JOB title. _____
- 4 Give TITLE of presentation. _____
- 5 Give REASON. _____
- 6 Give STRUCTURE. _____
- 7 Give LENGTH. _____
- 8 VISUAL AIDS I plan to use. _____
- 9 No QUESTIONS until the end. _____
- 10 START first part. _____

Language cards

- a I plan to show you some slides and a short video during my presentation.
- b So, first of all, let's take a look at ...
- c I'm very grateful that you could all come today.
- d I'm going to talk for ...
- e If there is anything you would like to ask me, please would you wait until the end of the presentation.
- f My name is ...
- g My talk will be in four main parts.
- h The subject of my presentation today is ...
- i I'm the ...
- j I'm going to talk about this because ...

You have to show this visual aid to the people at your presentation. Can you say where each place is? Make complete sentences.

Example: *The main office is in the top left-hand corner.*

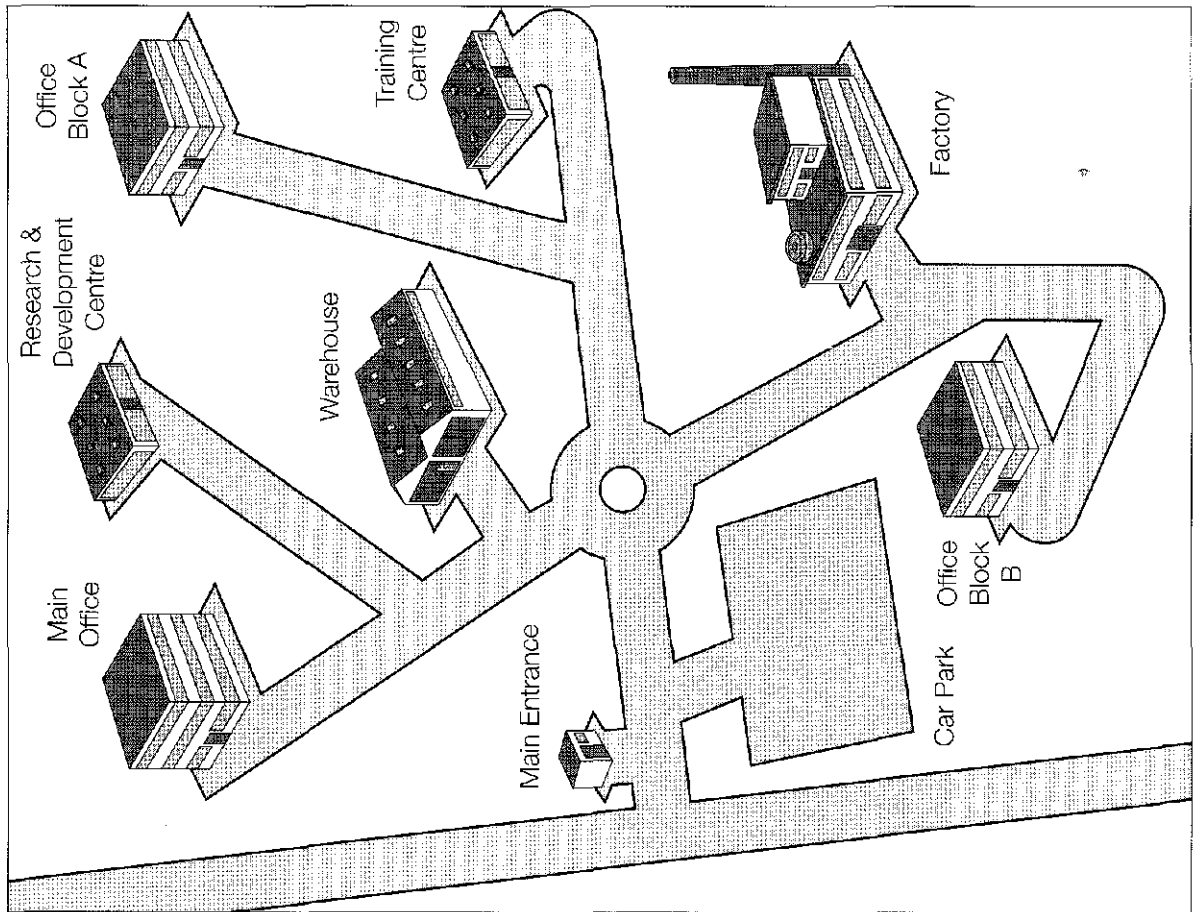

- 1 The main office is **in** the bottom right-hand corner.
- 2 The car park is **on** the left-hand side.
- 3 The factory is **at** the bottom.
- 4 The R&D centre is **at** the top right-hand corner.
- 5 The warehouse is **at** the top.
- 6 The training centre is **at** the right-hand side.
- 7 Office block A is **in** the bottom left-hand corner.
- 8 Office block B is **in** the top left-hand corner.
- 9 The main entrance is **in** the centre.

Fill in the missing words in the sentences below. Choose from the following. There are two possible answers for number 8.

agenda any other business chair closed
 decision item matters arising meeting
 minutes monthly point room start

- 1 It was a terrible meeting.
- 2 It was planned to _____ at nine o'clock.
- 3 But no one had the _____.
- 4 And no one knew which _____ to go to.
- 5 The _____ arrived at 9.15. At last we thought we could start.

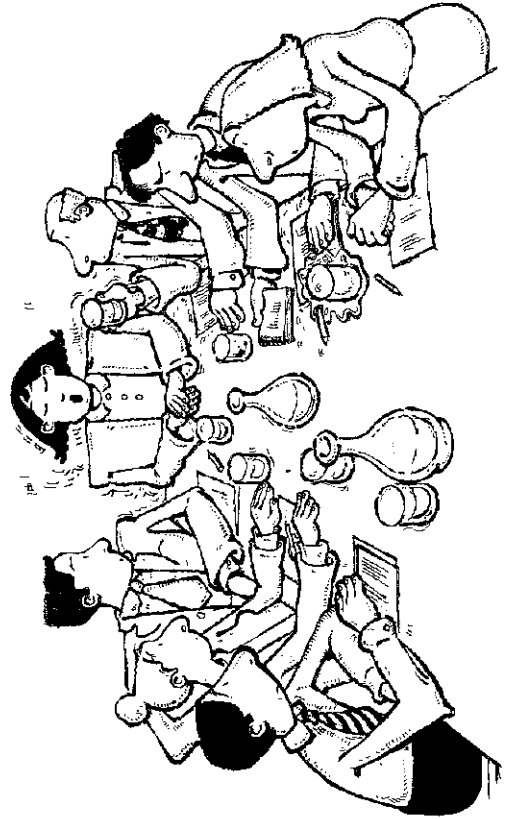

'Thank you, everyone. That was an interesting discussion about how long the meeting should last. It's a pity we don't have time to discuss anything else.'

- 6 But no one had the _____ of the last meeting, so the secretary had to go and look for them – and to make copies of the agenda.
- 7 It took a long time to go through the _____ from the last meeting.
- 8 At last we got to the main _____ on the agenda.
- 9 We talked for two hours but did not reach a _____.
- 10 There was no time for _____.
- 11 The chair declared the meeting _____ just before midday.
- 12 Thank goodness it's only a _____ meeting!



Some useful vocabulary for meetings:

The **agenda** – the list of things to discuss.

The **minutes** – the report of a meeting.

The **chair** – the person who leads the meeting.

Matters arising – things to discuss from the last meeting.

Any Other Business (AOB) – the chance for people to discuss things which are not on the agenda.

37 Meetings 2

Meetings have different kinds of objectives. Match what people are saying (a-i) with the correct meetings (1-9).

- 1 Meeting to maintain contact d
- 2 Brainstorming meeting
- 3 Decision-making meeting
- 4 Discussion meeting
- 5 Annual General Meeting
- 6 Information meeting
- 7 Negotiation
- 8 Planning meeting
- 9 Problem-solving meeting

a We've got to find a way of making the TX2 and the TX3 communicate with each other. Could the technical people come in next Tuesday?

b We're meeting the unions on the 21st. We're going to discuss with them their demand for a salary increase for next year.

c I'd now like to call on the Chairman of the Board to give us his report on the year's activities.

d If you're in the country next month, come over and see us: it would be good to get a chance to talk and discuss how our relationship could develop.

e I've called this meeting because I want to tell you about recent developments in the KG23 project.

f OK, let's see how many ideas we come up with in the next 15 minutes. I'll write them up on the whiteboard.

g The atmosphere on the first floor is terrible. Could we have a meeting about it? I don't know if we can get a decision without Cedric and Jan, but at least we can talk about it.

h We have just one point on today's agenda: to decide on the launch date for Zakko.

i Can we meet next Friday? We need to plan the next three stages of the AK94 project.



A **brainstorming meeting** is a more informal meeting where everyone should feel free to make suggestions and to give their ideas, in order to develop new ideas or to solve a problem. There are fewer rules and there may not be an agenda for this kind of meeting.

A **troubleshooting meeting** is a mixture of problem-solving and brainstorming, when everyone at the meeting tries to find an answer to a current (and often) urgent problem. There is more likely to be a chairperson, an agenda and rules for the discussion in this kind of meeting.

38 Meetings 3

SECTION 5

Fill in the spaces in the sentences by changing the nouns on the right into verbs.

- 1 Meetings are good if everyone prepares for them very carefully in advance. **preparation**
- 2 First of all, we have to _____ who should be the chair. **decision**
- 3 I _____ that Mr Power should chair the meeting. **suggestion**
- 4 I _____ that he is the right man for the job. **agreement**
- 5 He is the only person here who can _____ the situation properly. **analysis**
- 6 He can _____ the problem if anyone can. **solution**
- 7 Mr Hong, please would you not _____ when I am speaking. **interruption**
- 8 Next point. I _____ that everyone here should get a 20% salary increase next year. **proposal**
- 9 We must _____ for the next stage of the project. **planning**
- 10 Celia is now going to _____ the sales figures for the last quarter. **presentation**

SECTION 5

- 11 I hate the weekly sales meeting. Archie and Fatima always _____ all the time. **argument**
- 12 I _____ with what you say. I think Steve is the problem. **disagreement**
- 13 We need to _____ again soon. **meeting**
- 14 We have to _____ this question in more detail. **discussion**
- 15 So, I'd like to _____ what we have said so far. **summary**
- 16 Good. So who is going to _____ all this to the Board? **report**



Archie and Fatima always argue all the time.

39 Business trends

In business it is important to be able to talk about things which go up and down (like prices and profits). Write the letter of each graph (a–j) next to the correct description (1–10).

- 1 The share price reached a peak. i
- 2 The share price rose slightly.
- 3 The share price went up steadily.
- 4 The share price increased dramatically.
- 5 The share price reached a low point and then recovered.
- 6 The share price decreased slowly.
- 7 The share price fluctuated.
- 8 The share price levelled out.
- 9 The share price fell rapidly.
- 10 The share price went down steadily.

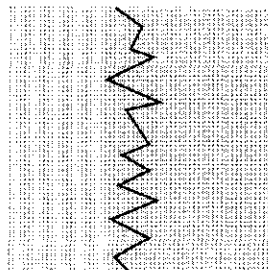
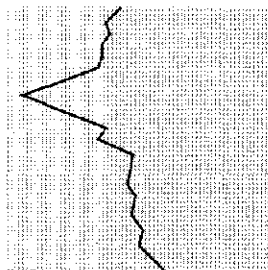
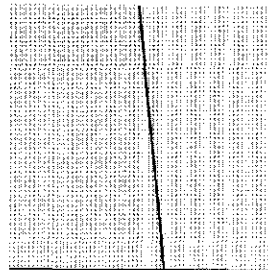
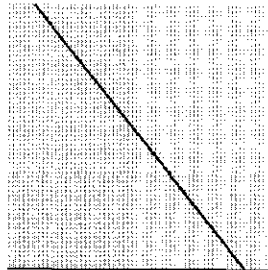
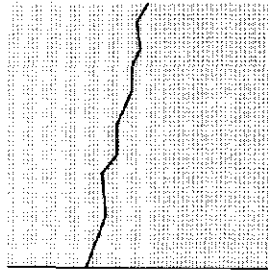
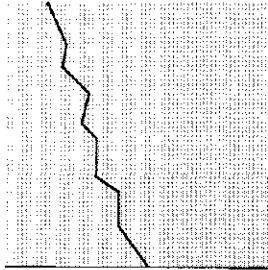
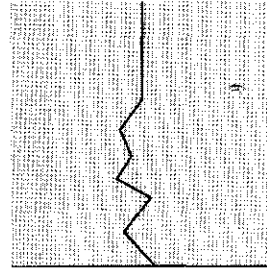
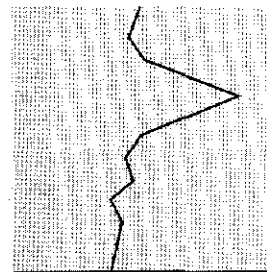
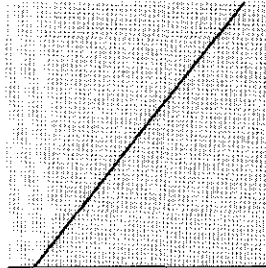
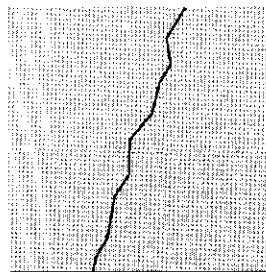

40 Business documents 1

Match the document extracts (a–l) with the correct terms (1–12).

- | | | | |
|-----------------|-------|-----------------|-------|
| 1 agenda | _____ | 7 sales report | _____ |
| 2 order form | _____ | 8 newsletter | _____ |
| 3 minutes | _____ | 9 memo | _____ |
| 4 mailshot | _____ | 10 letter | _____ |
| 5 invoice | _____ | 11 contract | _____ |
| 6 annual report | _____ | 12 user's guide | _____ |

a You can use toolbars for quick access to commonly used commands and tools. When you first start the software, the Standard and Formatting toolbars are displayed just below the menu bar and the Drawing toolbar is displayed vertically on the left side of the window...

b Dear Ms Zelenka,
With reference to your recent call, please note that the goods you wish to order are currently out of stock.

c

To:	All employees in H section
From:	GBH
Subject:	Restroom facilities for H section staff
Date:	28 July

It has recently come to my notice that a number of employees in H section...

d

**POWER ENTERPRISES UK
CELEBRATES ITS MOVE TO
FRISBEE HOUSE**

Power Enterprises UK has just celebrated its move to new premises at Frisbee House, a beautiful listed building at the heart of the historic centre of Bristol, and just a few minutes' walk from ...

- e**
- It was agreed that departmental running costs must be cut by 10%. Arturo will present his proposal at the next meeting.
 - Martha's presentation ceremony will be on 9 November. Everyone will attend.
 - The next departmental meeting will be on...

f

All prices are inclusive of VAT, postage and packing. If you wish to pay by Visa or American Express card, please complete the form at the bottom of the page. If you are not entirely satisfied with your goods, we shall be happy to...

9

This has been quite a good year for Flinco. Although the general economic situation was very difficult, sales increased by 7.3% and net income by 12.7%. At the same time, we reduced our workforce by almost 15% and continued to increase the range of products...

- h**
- Minutes of the last meeting and matters arising.
 - The Zakko launch.
 - Problems in H section...

i

Figures for the Western region are generally good although the seasonal fall in sales of the XJ31 is stronger than usual and a major effort will be needed to bring sales up to target by the end of the quarter.

Both Central and Northern have done well across the whole range despite ...

j

115 units of XJ45 at £23.50 per unit	£2,702.50
Less 15% discount	£405.37
Plus VAT at 17.5%	£402.00
Plus postage and packing	£360.05
Total	£3,059.18

Payment within 30 days of issue.

k

Dear Ms Bazalgette,

Have you ever dreamed of owning your very own holiday home in an exotic location? I am writing to tell you that thanks to Zangief Timeshare Inc., these dreams could become a reality!...

- l**
- The SUPPLIER is entitled to modify the material ordered before delivery, provided such modifications do not affect the prices, delivery dates, quality performances or mechanical characteristics.
 - In all other cases, the PURCHASER's prior written permission is required to perform changes to the material.

41 Business documents 2

Write the types of written communication in the box next to the correct definitions.

agenda annual report contract directory fax ~~in-house magazine~~
 invoice ~~mailshot~~ memo minutes newsletter order form
 price list sales brochure sales report user manual

- 1 it tells people – usually people inside the company – about the life of the organization
in-house magazine
- 2 a report of a meeting _____
- 3 a letter sent at the same time to a number of customers or possible customers, for example about a new product or service

- 4 a paper which you fill in when you want to buy something from a company

- 5 an internal message, usually from one person to a group of people

- 6 a list of things to discuss at a meeting

- 7 it tells people – usually people outside the company – about the life of the organization

- 8 it gives information about the company's products

- 9 it tells you how much products cost

- 10 a book with lists of telephone numbers or other information

- 11 the paper which tells you how much you must pay when you buy something from a company

- 12 a document which tells you about the company's performance over the year, including the accounts for the year

- 13 a legal agreement between two parties

- 14 a message sent by facsimile machine

- 15 it tells you how a piece of equipment works

- 16 it contains figures on how much money people have spent on the company's products in, for example, a month

42 Visuals in written communication

Match the pictures (a-i) with the correct types of visual (1-9).

- 1 bar graph
- 2 diagram
- 3 flow chart
- 4 line graph
- 5 map
- 6 organigram
- 7 pie chart
- 8 plan
- 9 table

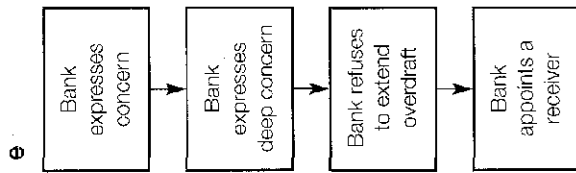

f

SUNRISE AND SUNSET TIMES						
Day	Belfast	Glasgow	London			
Sat 6	08.45	16.34	08.46	16.00	08.05	16.07
Sun 7	08.47	16.16	08.45	16.01	08.05	16.08
Mon 8	08.44	16.17	08.44	16.03	08.04	16.10
Tue 9	08.43	16.19	08.44	16.04	08.04	16.11

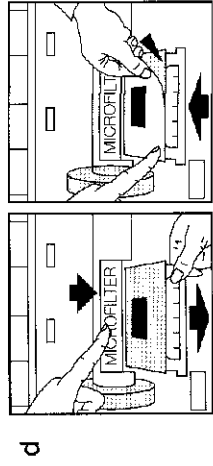
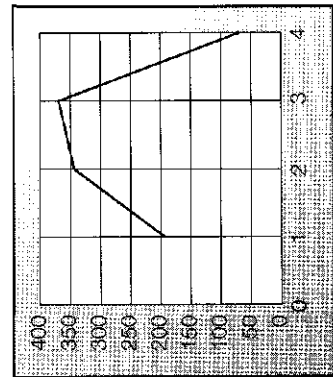
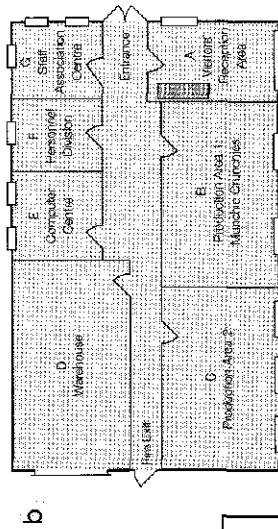
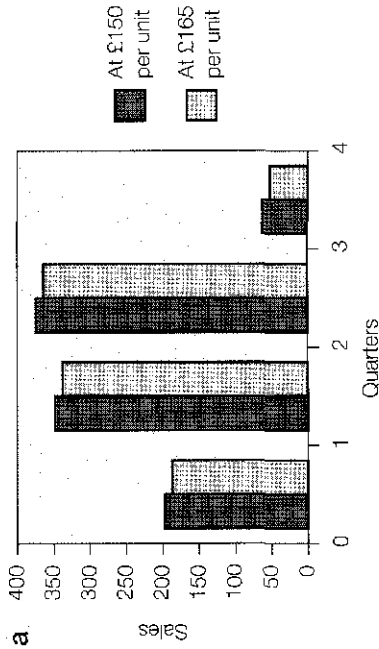
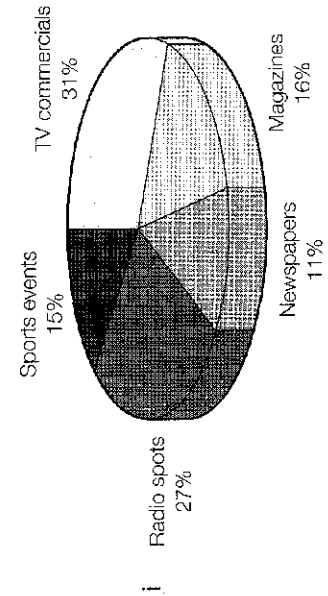
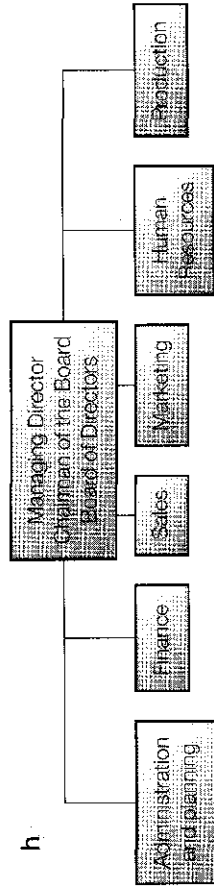
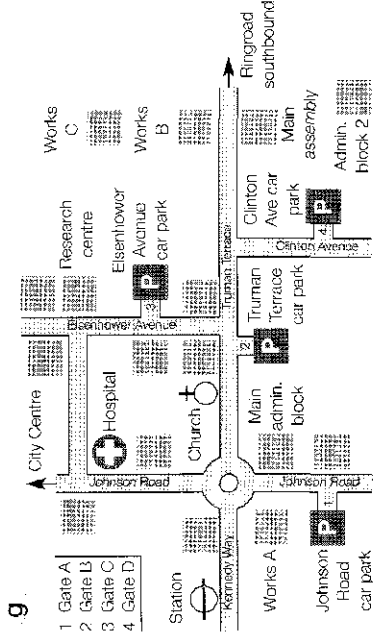

43 Business letters

Match the letters (a–n) with the different parts of the letter (1–14).

- 1 salutation _____ e _____
- 2 signature _____
- 3 letterhead _____
- 4 enclosures _____
- 5 complimentary close _____
- 6 final paragraph _____
- 7 sender's title _____
- 8 sender's address _____
- 9 main paragraph _____
- 10 website _____
- 11 introductory paragraph _____
- 12 date _____
- 13 sender's name _____
- 14 addressee's name and address _____

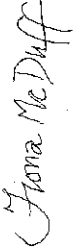
a	
b	<p>Great Eastern Associates 377 King James Street Edinburgh ED4 1MU Scotland Tel: 00 44 1301 567567 fax: 00 44 1301 567586 e-mail: infogreas@warmmail.com</p>
c	7 February 2002
d	<p>Mr Felix Dubois Banque Régionale du Sud-ouest 14 Route Nationale 24340 Mareuil France</p>
e	Dear Mr Dubois
f	Thank you for your recent enquiry.
g	I enclose our brochure which gives you information about the services we offer and our prices. If you would like any more information, please do not hesitate to contact us.
h	We look forward to hearing from you.
i	Yours sincerely
j	
k	Fiona McDuff
l	Partner
m	Enc. GE Associates brochure
n	<p>Great Eastern Associates Partners: F. McDuff, R. McDuff, Z. McDuff, H. McKechnie www.greas.co.uk</p>

44 E-mails

There can be a big difference between the styles used for writing e-mails and for writing letters. Often – but not always – e-mails are less formal. On the next page is a table of different expressions used for writing letters and e-mails. Write each phrase below in the correct place in the table.

wbow

Re:

Dear Sam

Hi Sam

Sorry about...

Please...
...attached

I should be grateful if you would...

Please accept our apologies for...

We regret to inform you...

Please find enclosed...

With reference to...

I'm afraid...

We are very pleased to inform you...

If you need more information, please do not hesitate to contact us.

I'm happy to tell you...

With best wishes

	Letters	E-mails
Greeting	1 <i>Dear Sam</i>	2
Topic	3	4
Request	5	6
Apology	7	8
Documentation	9	10
Bad news	11	12
Good news	13	14
Conclusion	15	16
Closing	17	18

45

Business forms

SECTION 6

Mary McCann has filled in the form below. Write the following headings in the correct spaces on the form.

Business address	Company	Date	Date of birth
Extension number	First names	Job title	Marital status
Place of birth	Postcode	Signature	Suffern
Work telephone number			

1	Surname	McCANN
2		MARY ELIZABETH
3		ACE PROMOTIONS
4		DIRECTOR OF MARKETING
5		65 KINKLADZE WAY, LONDON
6		NW6 7TL
7		00 44 020 7965 4200
8		372
9		14 MAY 1969
10		CAIRO, EGYPT
11		MARRIED
12		20 JANUARY 2002
13		<i>M E McCann</i>



Mary has filled in an internal company form. But if she had wanted a job with your company, which information could your company ask for? And which information could it not ask for? For example, in some countries, companies cannot ask if candidates are married or not.

46

The CV

SECTION 6

Archie Wong's CV has got mixed up in the word processor. Help him to put the items in the right order by matching the information (a-j) with the correct headings (1-10).

1	Name	f	a	English, French, Cantonese
2	Date of birth		b	British
3	Nationality		c	Military history, climbing, chess
4	Education		d	Loopers and Kylebrand, Chartered Accountants, 1988-91
5	Qualifications			Gabstock and Thring, Chartered Accountants, 1991-94
6	Experience		e	Assistant General Manager, Power Enterprises UK
7	Current position		f	Archibald Fitzpatrick Wong
8	Responsibilities		g	8 September 1967
9	Languages spoken		h	MA in Politics and Economics 1988
10	Leisure interests		i	Member, British Institute of Chartered Accountants 1991 MBA 1995
			j	General management of the company
				Achieved 25% growth per year over the last four years
				Bootham School, York, 1980-84
				Keble College, Oxford, 1985-88
				INSEAD, Fontainebleau, France, 1994-95

47 Business functions

Match each group of words (a-o) with the correct business function (1-15).

- 1 Human Resources f
- 2 Purchasing _____
- 3 Marketing _____
- 4 Training _____
- 5 Legal _____
- 6 Information Technology _____
- 7 After-sales _____
- 8 The Board _____
- 9 Finance _____
- 10 Distribution _____
- 11 Sales _____
- 12 Production _____
- 13 Research and Development _____
- 14 Accounts _____
- 15 Communications _____

- a laboratory test scientist trial
- b parts assembly line shift supervisor
- c PR event press release company image house magazine
- d retail outlet monthly figures discount commission
- e capital dividend cash flow share price
- f recruitment training safety employee relations
- g invoice bookkeeping VAT credit note
- h network screen hard disk memory
- i questionnaire mailshot prospect advertisement
- j bulk buying office supplies order delivery
- k shareholder executive director non-executive director chairman
- l course design student needs analysis timetable
- m hot line telephone support complaint 24-hour service
- n stock control lorry warehouse packaging
- o contract patent copyright signatory

48 Finance

Match each quote (a-j) with the correct description (1-10)

- a We haven't put enough profit back into the company. 8
- b We don't have enough money coming into the company for us to pay our own bills. _____
- c We made more money this year than last year. _____
- d Last year, we spent more money than we earned. _____
- e We have to spend less on things like electricity, rent and postage. _____
- f At the moment we are spending more than we said we would at the beginning of the year. _____
- g We have decided to bill customers before delivery of the goods. _____
- h We think the figures for next year are going to be very positive. _____
- i We don't make enough money on the sale of each unit. _____
- j We can't do it on our own so we should ask the government for financial help. _____

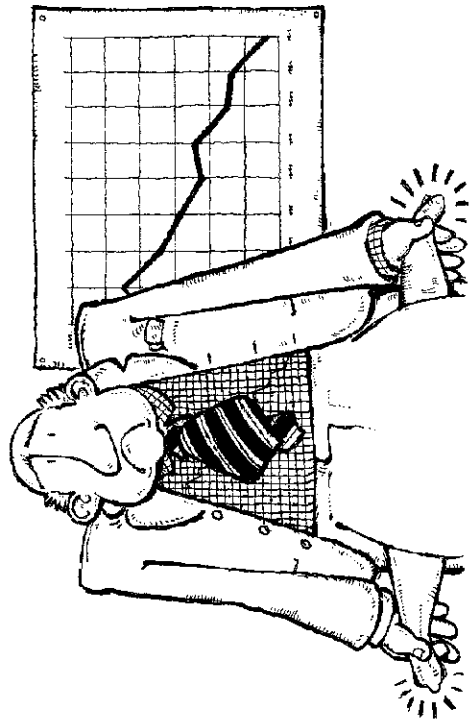

Cash flow is poor.

1

The company is thinking about asking for a subsidy.

2

The forecasts are good.

3

Profits are up.

4

The invoicing procedure has been changed.

5

Spending is over budget.

6

Cash flow is poor.

7

There was a loss.

8

Investment is too low.

9

Overheads are too high.

10

Margins are too low.

Fill in the crossword. All the answers are connected with marketing.

Across

- 2 When a company has a new product, it has to decide on a L A U _____ date.
- 4 If you want to know what people think about a product, you do some market R E S _____.
- 6 The P A _____ of a product is very important: the company has to think carefully about how the product should look.
- 8 The objective of advertising is to build up B R _____ loyalty.
- 11 Some companies show the same television C O M M _____ in several different countries.

Down

- 1 You ask people to fill in Q U _____ so you can get information about what they want or need.
- 3 Where to sell the product is a question of P L _____: another of the 'Seven Ps' of marketing.
- 5 One recent advertising C A _____ lasted for over a year.
- 6 P R _____ of a product is the general process of getting people to know your product, to like your product through advertising and so on, so that they finally buy it: another of the 'Seven Ps'.
- 7 One way to inform people about your product is to A D _____ it on TV.
- 9 You employ an advertising A G _____ to create a product image.
- 10 One more of the 'Seven Ps' of marketing is P R _____: you have to decide how much the consumer can pay for it.

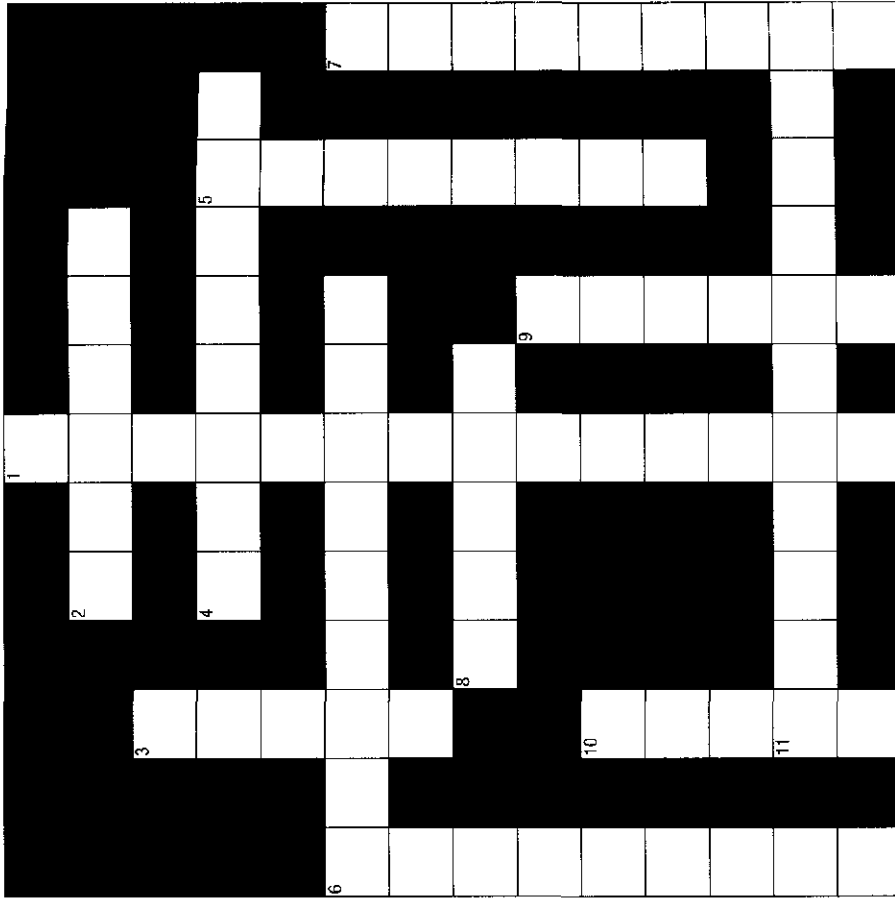

Three of the 'Seven Ps' of marketing are in the crossword. The four others are:

Product – the goods or services a company provides.

People – everyone involved, from producer to consumer.

Physical evidence – anything that shows the existence of the company, e.g. its buildings, vehicles, website, stationery.

Process – the interaction between everyone involved.

50 Human resources

Match each group of human resources terms (a-k) with an appropriate heading (1-11).

- | | |
|--------------------------|---------|
| 1 Working conditions | k _____ |
| 2 Recruitment | _____ |
| 3 Training | _____ |
| 4 Management development | _____ |
| 5 Equal opportunities | _____ |
| 6 Pay | _____ |
| 7 Health and safety | _____ |
| 8 Employee relations | _____ |
| 9 Employment law | _____ |
| 10 Appraisal | _____ |
| 11 Pensions | _____ |

- | | | | | |
|---|-----------------|----------------|-------------------|------------------------|
| a | retire | portable | period of service | contribution |
| b | accident | warning | inspector | first aid |
| c | strike | deal | dispute | agree |
| d | contract | tribunal | dismissal | union rights |
| e | time management | leadership | team building | assertiveness training |
| f | course | role-play | visual aid | self study |
| g | interview | objectives | performance | review |
| h | wages | bonus | commission | incentive |
| i | interview | apply | CV | headhunt |
| j | returner | flexible hours | crèche facilities | homeworking |
| k | duties | hours | holidays | full-time |



Some companies employ a **headhunter** to help them find key personnel. This person tries to attract especially able people to a job by offering them better pay, more responsibility, etc.

A **tribunal** is a court of people officially appointed to deal with special matters. For example, a case of unfair dismissal may be heard in an employment relations tribunal.

A **bonus** is an additional payment on top of what is usual or expected. It may take the form of a share of a company's profits paid out to the people who work there.

Other terms for the word **crèche** are **day-care centre** or **nursery**.

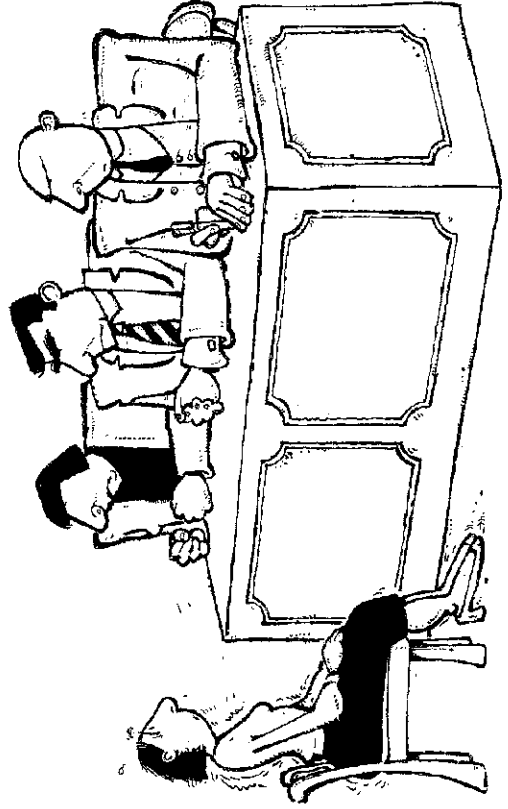

The interview.

51 Computing

Fill in the missing words in the sentences below. Choose from the words in the box. There are two possible answers to number 3.

database desktop publishing directories disk drive
folder help internet laptop modem palmtop
software spreadsheet word processing

- 1 The screen and the keyboard are part of the hardware.
The operating system is part of the software.
- 2 One way to safeguard information in your computer is to copy files from the hard _____ to a zip drive.
- 3 To keep your files in order, you can make and keep them in different _____.
- 4 If you want to work mainly with text on your computer, you need _____ software.
- 5 If you want to work mainly with figures, you need _____ software.
- 6 If you want to produce a good-looking magazine or in-house newsletter, you need some _____ software.
- 7 If you want to manage and manipulate large amounts of information, for example about your company's clients, you need _____ software.
- 8 If you want to use a computer when you are on the move, the best kind of computer to use is a _____ or a _____.

- 9 If you do not know how to do something in a particular programme, you can use the _____ facility.
- 10 To be able to run CD-ROMs on your computer, you need a CD-ROM _____.
- 11 For your computer to be able to send and receive information via a telecom link, you need a _____.
- 12 You can use the _____ to get all kinds of information from computer databases all over the world.

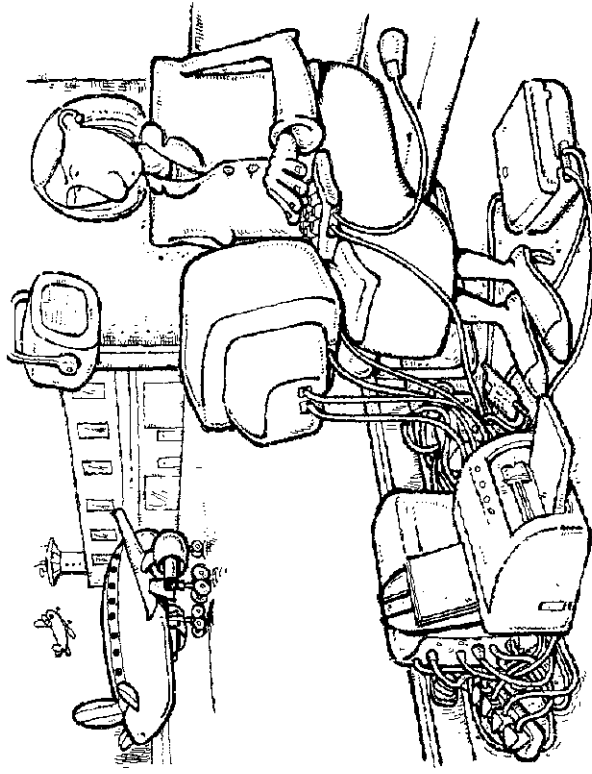

The best kind of computer for people on the move?

Production 1: in the factory

Match the items in the picture (a-n) with the correct terms (1-14).

- 1 supervisor _____
- 2 hard hat _____
- 3 shop-floor workers _____
- 4 overalls _____
- 5 packer _____
- 6 assembly line _____
- 7 machine _____
- 8 machine guard _____

- 9 robot _____
- 10 forklift truck _____
- 11 shelving _____
- 12 waste bin _____
- 13 fire extinguisher _____
- 14 safety notice _____

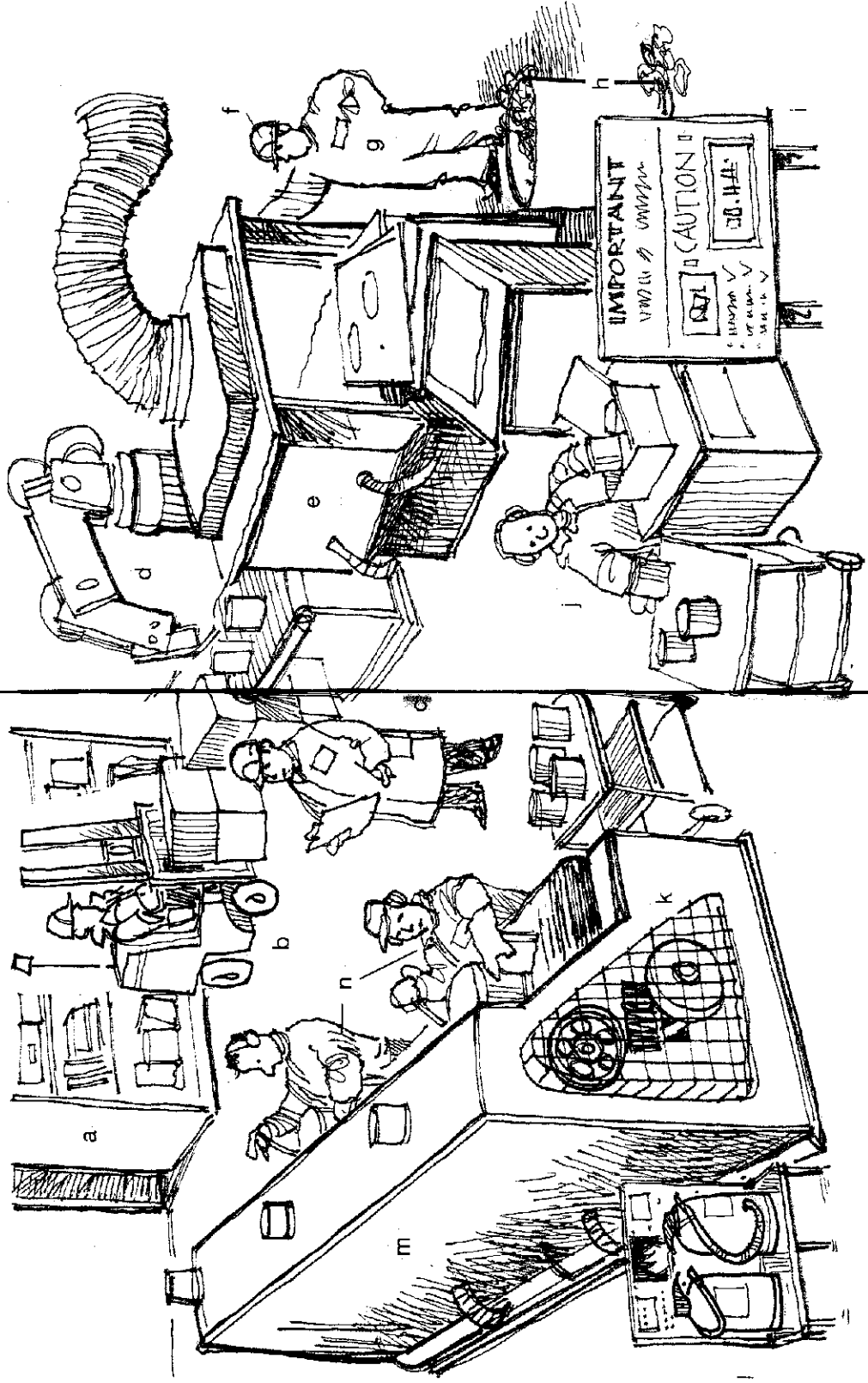

53

Production 2: from factory to home

The sentences in the chart below describe how goods get from the factory to your home. Match the letters in the chart (a–m) with the words or phrases they represent (1–11). Some words or phrases are used more than once.

- 1 a consumer
- 2 a distributor
- 3 a manufacturer
- 4 a retail outlet
- 5 a warehouse
- 6 by
- 7 in
- 8 makes
- 9 sells
- 10 through
- 11 transports

Person	Activity	Goods	Preposition	Place
a	b	cars	c	a factory.
A wholesaler	stores	machine tools	d	e
f	g	frozen foods	h	road, rail, sea or air.
A retailer	i	televisions	j	k
l	buys	video cassette recorders	at / through	m

54 Business and the environment

What is the company's environmental policy? Fill in the missing words in the sentences below. Choose from the following:

- audit ~~batteries~~ bulbs green packaging photocopies
 plastic recycle scrap suggestions waste

- 1 In future, we should only buy rechargeable batteries.
- 2 We should _____ all the glass bottles and newspapers we use.
- 3 There should be different bins in every office for different kinds of _____.
- 4 We should make sure that everyone separates paper from _____.
- 5 We should encourage office staff to use _____ paper for notes and messages.
- 6 We should ask people to make fewer _____.
- 7 We should always use long-life light _____ to light our offices.
- 8 We should reduce the amount of _____ on our products.
- 9 We should ask a firm of specialist consultants to do an environmental _____ of our activities.
- 10 We should encourage everyone to make _____ about how to make environmental savings.
- 11 We want to continually improve our _____ image.

Sally Pereira has just been made Chief Executive Officer of Gratesko, a big retail chain. She wants to improve working conditions for women in the company. Match the features in her policy (1–10) with the descriptions (a–j).

- | | | |
|----|-----------------------------------|----------|
| 1 | Guarantee EQUAL PAY. | <u>h</u> |
| 2 | Introduce FLEXITIME. | _____ |
| 3 | Improve MATERNITY LEAVE. | _____ |
| 4 | Encourage HOMEWORKING. | _____ |
| 5 | Allow more DAYS OFF. | _____ |
| 6 | Increase the number of RETURNERS. | _____ |
| 7 | Introduce JOB SHARING. | _____ |
| 8 | Provide CRÈCHE FACILITIES. | _____ |
| 9 | Provide EQUAL OPPORTUNITIES. | _____ |
| 10 | Break the GLASS CEILING. | _____ |

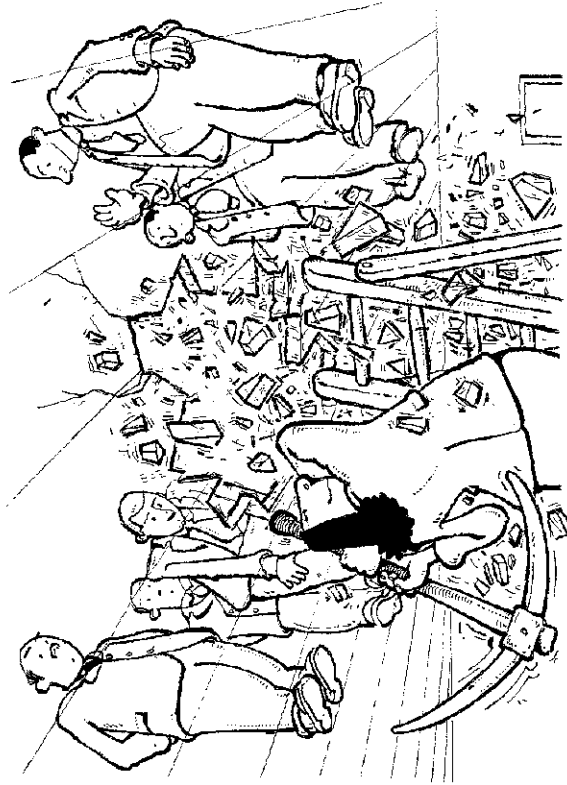

Breaking through the glass ceiling.

- a Give employees more chance to stay at home if their children are ill.
- b Make it easier for women to move into senior management positions.
- c Give women more time away from work when they have babies.
- d Give employees computers with an internet connection so they can sometimes work from home.
- e Organize a facility where employees may leave their young children during the working day.
- f Give employees more freedom about the time of day when they start and stop work.
- g Encourage women who left the company to start families to come back to their old jobs later on.
- h Give women the same money as men for doing the same kind of work.
- i Give women the same chance to get jobs as men.
- j Allow partners or colleagues to share the same position.



in the companies you know:

Is there always the same percentage of women in senior management as in the company as a whole?

What is each company's policy on **equal opportunities**?

56 Business and the economy

Match the statements about the imaginary country of Zakaria (1–10) with their (similar) meanings (a–j).

- 1 There are 20 million people in Zakaria who want to work. One million do not have jobs. d
- 2 Some industries are privately owned and some are state-owned.
- 3 Last year the size of the economy was \$100 billion. This year it is \$101 billion.
- 4 Prices are much higher this year than last year.
- 5 Banking, insurance and tourism, etc., are important to the country's economy.
- 6 But the production of cars, machine tools, white goods, etc., is still the most important part of the economy.
- 7 At the moment, the economic situation is bad. There is a danger that the economy will get smaller, not bigger this year.
- 8 Most working people have to pay about a third of their income to the government.
- 9 Today you can buy 10 Zaks for one US dollar. Last year it was the same.
- 10 Two million workers are members of labour organizations.

- a The EXCHANGE RATE is stable.
- b The standard RATE OF INCOME TAX is 30%.
- c The MANUFACTURING SECTOR is larger than the service sector.
- d The UNEMPLOYMENT RATE is 5%.
- e People are afraid of a RECESSION.
- f The GROWTH RATE was 1%.
- g The economy has a large SERVICE SECTOR.
- h TRADE UNION MEMBERSHIP is about 10% of the whole workforce.
- i Zakaria has a MIXED ECONOMY.
- j The RATE OF INFLATION is high.

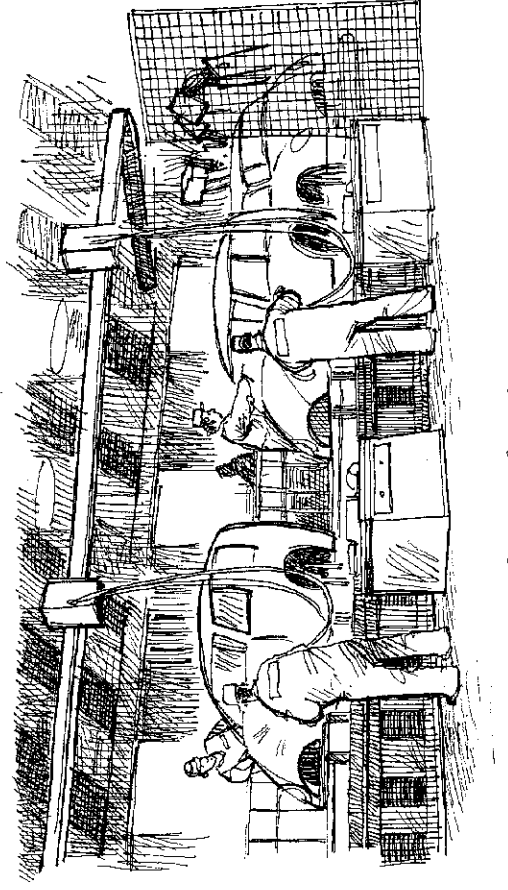

The manufacturing sector

57

Outsourcing

Power Enterprises wants to concentrate on its core business. Match the pictures (a-i) with the outsourced departments (1-10).

- 1 Mail services h
- 2 Catering services _____
- 3 Payroll administration _____
- 4 After-sales service _____
- 5 Security _____
- 6 Cleaning _____
- 7 IT _____
- 8 Distribution _____
- 9 Storage _____
- 10 Training _____

a

PE WIDOWS	JAMES INGHAM	05 JUN 14
DEPARTMENT	ENGINEERING	05 JUN 14
YEAR TO DATE	2008-02	2008-02
	681.65	681.65
	2.53	9.6
	492.92	70.16
	NET PAY	495.04

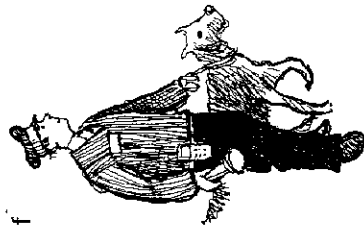
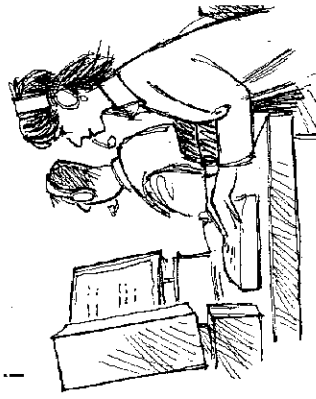
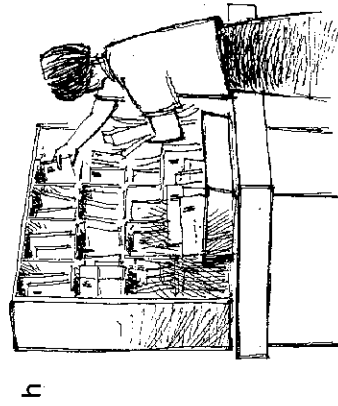
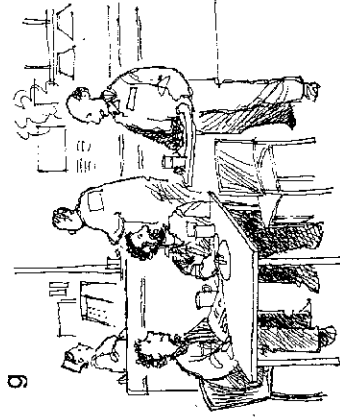
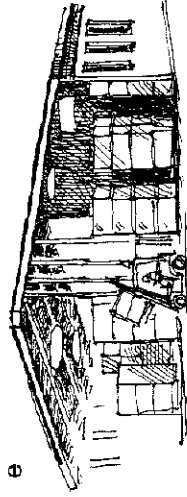
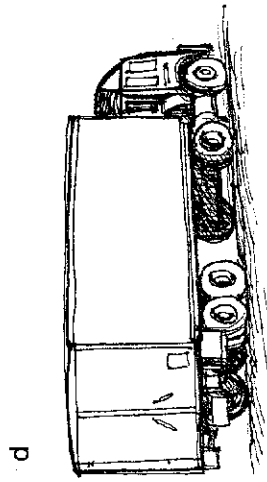
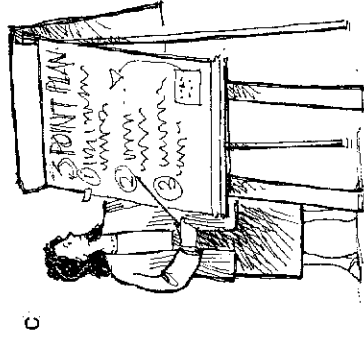
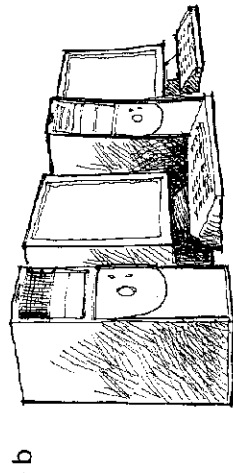

Outsourcing happens when a company asks another company to do some of its work. Some companies like to employ people just for their **core business** - to work on the main products they make or the main service they provide. Some companies now outsource functions like human resources. It can often be cheaper for a company to get certain kinds of service by outsourcing rather than by employing more people directly.

Business initials and abbreviations

Jacqui has received similar e-mails from two different people. What do the initials and abbreviations in the second memo mean?

- 1 FYI for your information 7 ASAP _____
- 2 CEO _____ 8 VAT _____
- 3 VP _____ 9 n/a _____
- 4 HR _____ 10 PA _____
- 5 R&D _____ 11 OK _____
- 6 AGM _____

Inbox

1 | 0 | Subject: Information Kim update | From: Kim | Sent: Today

Jacqui,
You should know that the boss has told both the personnel and development directors to get the figures for the yearly shareholders' meeting urgently. Some of the tax details are not out. Could you get your secretary or someone to do them? No problem?

Inbox

1 | 0 | Subject: FYI | From: Fidel | Sent: Today

Jacqui,
The CEO has told the VPs for HR and R & D to get the figures for the AGM ASAP. Some of the VAT details are n/a at the moment. Could you get your PA to do them? OK?

From first to last

There are three verbs in each of the groups below. First, match each group of verbs with a noun in the table. Then write the verbs in the right order in the table from what happens first to what happens last.

- 1 start up _____ complete _____ manage _____ **f**
- 2 sell off _____ run _____ set up _____
- 3 discuss _____ solve _____ identify _____
- 4 negotiate _____ propose _____ sign _____
- 5 test _____ research _____ launch _____
- 6 set _____ meet _____ work to _____
- 7 postpone _____ fix _____ hold _____
- 8 build _____ break up _____ lead _____
- 9 receive _____ resolve _____ deal with _____
- 10 keep _____ fire _____ hire _____
- 11 give _____ practise _____ prepare _____

	First verb	Second verb	Last verb	Noun
a				a company
b				a meeting
c				staff
d				a new product
e				a presentation
f	start up	manage	complete	a project
g				a team
h				a problem
i				a deadline
j				a complaint
k				a deal

What is your company's Unique Selling Proposition or USP? Fill in the missing words in the sentences below. Choose from the following:

care competitors —employees empowered experience
flexible goal invest quality talking

- 1 Our employees are the best trained in the country.
- 2 We look at what our _____ do, then we do it better.
- 3 We spend more time _____ to our customers than any other company in our field.
- 4 The _____ of our goods and services is second to none.
- 5 We regularly win industry awards for our levels of customer _____.
- 6 We have more years of _____ of working in this sector than any other organization in this country.
- 7 We have a more _____ approach to the needs of our customers than any of our competitors.
- 8 We _____ more in research and development than anyone else in the business.
- 9 All our people are _____ to take decisions on the spot about what is best for the customer.
- 10 Our _____ is to be number one in every area in which we operate.

Answers

Test 1

- 1 in
- 2 in / for
- 3 in
- 4 in
- 5 on
- 6 for
- 7 in
- 8 on
- 9 on
- 10 for

Test 2

- 1 company
- 2 products
- 3 leader
- 4 share
- 5 employees
- 6 subsidiaries
- 7 customers
- 8 competitors
- 9 shareholders
- 10 turnover
- 11 profit
- 12 share price

Test 3

- 1 j
- 2 f
- 3 g
- 4 m
- 5 c
- 6 b
- 7 d
- 8 k
- 9 e
- 10 h
- 11 a
- 12 i
- 13 l

Test 4

- 1 owner
- 2 Chief Executive Officer
- 3 director
- 4 boss
- 5 shareholder
- 6 investor
- 7 customer
- 8 supplier
- 9 leader
- 10 colleague
- 11 opposite number
- 12 manager

Test 5

- 1 salary
- 2 pension
- 3 benefits
- 4 stock option
- 5 car
- 6 expenses
- 7 health insurance
- 8 vouchers
- 9 bonus
- 10 income, rise
- 11 floor
- 12 secretary
- 13 office
- 14 deal

Test 6

- 1 CAREER
- 2 JOB
- 3 STARTED
- 4 LEFT
- 5 MOVED
- 6 PROMOTED
- 7 MADE REDUNDANT
- 8 JOINED
- 9 APPOINTED
- 10 FIRED
- 11 RETIRE
- 12 OFFERS

Test 7

- 1 k
- 2 f
- 3 c
- 4 a
- 5 j
- 6 d
- 7 i
- 8 g
- 9 b
- 10 h
- 11 e

Test 8

- 1 c
- 2 o
- 3 d
- 4 l
- 5 m
- 6 j
- 7 h
- 8 e
- 9 f
- 10 i
- 11 g
- 12 a
- 13 n
- 14 k
- 15 b

Test 9

- 1 main gate
- 2 identity card
- 3 security guard
- 4 main building
- 5 reception desk
- 6 receptionist
- 7 appointment
- 8 sign
- 9 badge
- 10 lift
- 11 floor
- 12 secretary
- 13 office
- 14 deal

Test 10

- 1 b
- 2 e
- 3 a
- 4 g
- 5 j
- 6 c
- 7 h
- 8 d
- 9 k
- 10 i
- 11 f

Test 11

- 1 f
- 2 l
- 3 h
- 4 k
- 5 e
- 6 a
- 7 j
- 8 c
- 9 d
- 10 b
- 11 i
- 12 g

Test 12

- 1 senior management
- 2 middle management
- 3 junior management
- 4 clerical grades
- 5 supervisory grades
- 6 skilled grades
- 7 semi-skilled grades
- 8 unskilled grades



Every company has, or should have, a **USP**. Your USP tells people what makes your business different from every other.

- Test 13**
 1 Chairman of the Board [a]
 2 Chief Executive Officer [b]
 3 Director of Finance [c]
 4 Director of Operations [e]
 5 Director of Marketing [g]
 6 Director of Human Resources [k]
 7 Director of Research and Development [n]
 8 Deputy Director of Finance [d]
 9 Factory Manager [f]
 10 National Sales Manager [h]
 11 Training and Development Manager [j]
 12 Compensation and Benefits Manager [m]
 13 Regional Sales Manager North/South [i or j]
 14 Regional Sales Manager South/North [i or j]
- Test 14**
 1 e 7 l
 2 f 8 j
 3 g 9 i
 4 b 10 k
 5 c 11 d
 6 a 12 h
- Test 15**
 1 head office
 2 regional headquarters
 3 local offices
 4 local agents
 5 factories
 6 warehouses
 7 research and development centres
 8 training centres
 9 office
 10 plant
- Test 16**
 1 family company
 2 state-owned
 3 privatized
 4 principal shareholders
 5 stakeholders
 6 subsidiaries
 7 parent company
 8 joint venture
 9 takeover
 10 hostile takeover
 11 merger
- Test 17**
 1 j 7 g
 2 e 8 b
 3 h 9 f
 4 k 10 a
 5 c 11 d
 6 i
- Test 18**
 1 tip
 2 check-in desk
 3 hand luggage
 4 excess baggage
 5 aisle
 6 seat belt
 7 connection
 8 reservation
 9 single
 10 waiter
 11 room service
 12 bill
- Test 19**
 1 MOBILE PHONE
 2 PAGER
 3 INTERNET
 4 WEBSITE
 5 E-COMMERCE
 6 E-MAIL
 7 LAPTOP
 8 PALMTOP
 9 DOT.COM
- Test 20**
 1 25th
 2 2002
 3 55
 4 3/4
 5 0.03
 6 0
 7 23.00
 8 34404562
 9 7.30
 10 7.30
 11 1/4
 12 2
- Test 21**
 1 h 8 b
 2 d 9 i
 3 j 10 f
 4 e 11 m
 5 c 12 a
 6 k 13 g
 7 l
- Test 22**
 1 neat
 2 warm
 3 cautious
 4 clever
 5 timid
 6 dependable
 7 easy-going
 8 self-assured
 9 adaptable
 10 consistent
 11 acceptable
 12 outstanding
- Test 23**
 1 untidy
 2 disorganized
 3 inaccurate
 4 unsystematic
 5 insensitive
 6 impatient
 7 unconventional
 8 untraditional
 9 unconvincing
 10 irresponsible
 11 inefficient
 12 insecure
 13 disobedient
 14 unreliable
 15 unpredictable
 16 unfriendly
 17 undiplomatic
 18 untrustworthy
 19 intolerant
 20 insincere
 21 unorthodox
 22 dishonest
 23 inexperienced
- Test 24**
 1 m 10 d
 2 k 11 p
 3 r 12 f
 4 q 13 c
 5 i 14 j
 6 a 15 h
 7 o 16 g
 8 l 17 c
 9 n 18 b
- Test 25**
 1 market
 2 price
 3 profit
 4 products
 5 customer
 6 financial
 7 staff
 8 business
 9 management
 10 executive
- Test 26**
 1 f 7 b
 2 i 8 h
 3 l 9 c
 4 g 10 j
 5 a 11 e
 6 k 12 d
- Test 27**
 1 fix
 2 deal
 3 solve
 4 reach
 5 decide
 6 make
 7 launch
 8 forecast
 9 raise
 10 cut
 11 play
- Test 28**
 1 d 8 b
 2 c 9 d
 3 a 10 c
 4 d 11 c
 5 b 12 a
 6 b 13 c
 7 a
- Test 29**
 1 advertising
 2 research
 3 computer
 4 market
 5 communications
 6 accounting
 7 production
 8 quality
 9 sales
 10 financial
- Test 30**
 1 manage
 manager
 management
 managerial
 2 analyse
 analyst
 analysis
 analytical
 3 organize
 organizer
 organizational
 organizational
 4 apply
 applicant
 application
 applicable
 5 compete
 competitor
 competition
 competitive
 6 decide
 decision-maker
 decision
 decisive
 7 invest
 investor
 investment
 -
 8 produce
 producer
 production
 productive
 9 regulate
 regulator
 regulation
 regulatory
 regulatory
 10 inform
 (informant)
 information
 informative
 11 persuade
 (persuader)
 persuasion
 persuasive

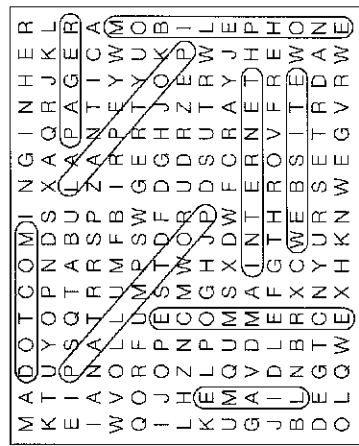

- Test 31**
- a) economic
 - b) economical
 - a) travel
 - b) trip
 - a) productivity
 - b) production
 - a) salary
 - b) wage
 - a) expenditure
 - b) expenses
 - a) personal
 - b) personnel
 - a) interviewer
 - b) interviewee
 - a) foreigners
 - b) strangers
 - a) blue-collar
 - b) white-collar
 - a) advertising
 - b) advertisement
 - a) line
 - b) staff
 - a) rising
 - b) raising
- Test 32**
- a
 - d
 - c
 - g
 - f
 - i
 - b
 - k
 - c
 - e
 - f
 - h
- Test 33**
- b
 - k
 - c
 - e
 - f
 - h
 - d
 - j
 - g
 - a
 - i
- Test 34**
- c
 - f
 - i
 - h
 - j
 - b
 - d
 - d
 - a
 - e
 - b
- Test 35**
- The main office is in the top left-hand corner.
 - The car park is in the bottom left-hand corner.
 - The factory is in the bottom right-hand corner.
 - The R&D centre is at the top.
 - The warehouse is in the centre.
 - The training centre is on the right-hand side.
 - Office block A is in the top right-hand corner.
 - Office block B is at the bottom.
 - The main entrance is on the left-hand side.
- Test 36**
- meeting
 - start
 - agenda
 - room
 - chair
 - minutes
 - matters arising
 - item/point
 - decision
 - any other business
 - closed
 - monthly
- Test 37**
- d
 - f
 - h
 - g
 - c
 - e
 - b
 - i
 - a
- Test 38**
- prepares
 - decide
 - suggest
 - agree
 - analyse
 - solve
 - interrupt
 - propose
 - plan
 - present
 - argue
 - disagree
 - meet
 - discuss
 - summarize
 - report
- Test 39**
- i
 - h
 - e
 - g
 - c
 - f
 - j
 - d
 - b
 - a
- Test 40**
- h
 - f
 - e
 - k
 - j
 - g
 - i
 - d
 - c
 - b
 - a
- Test 41**
- in-house magazine
 - minutes
 - mailshot
 - order form
 - memo
 - agenda
 - newsletter
 - sales brochure
 - price list
 - directory
 - invoice
 - annual report
 - contract
 - fax
 - user manual
 - sales report
- Test 42**
- a
 - d
 - e
 - c
 - g
- Test 43**
- e
 - j
 - a
 - m
 - i
 - h
 - i
 - d
- Test 44**
- Dear Sam
 - Hi Sam
 - With reference to...
 - Re:
 - I should be grateful if you would...
 - Please...
 - Please accept our apologies for...
 - Sorry about...
 - Please find enclosed...
 - ...attached
 - We regret to inform you...
 - I'm afraid...
 - We are very pleased to inform you...
 - I'm happy to tell you...
 - If you need more information, please do not hesitate to contact us.
 - Let me know if you need more information.
 - With best wishes
 - wbw
- Test 45**
- surname
 - first names
 - company
 - job title
 - business address
 - postcode
 - work telephone number
 - extension number
 - date of birth
 - place of birth
 - marital status
 - date
 - signature
- Test 46**
- f
 - g
 - b
 - j
 - h
 - d
 - e
 - i
 - a
 - c
- Test 47**
- f
 - j
 - i
 - l
 - o
 - h
 - m
 - k
- Test 48**
- 8
 - 6
 - 3
 - 7
 - 9
 - 5
 - 1
- Test 49**
- Across
- LAUNCH
 - RESEARCH
 - PACKAGING
 - BRAND
 - COMMERCIALS
- Down**
- QUESTIONNAIRES
 - PLACE
 - CAMPAIGN
 - PROMOTION
 - ADVERTISE
 - AGENCY
 - PRICE
- Test 50**
- k
 - i
 - f
 - e
 - j
 - h
 - b
 - c
 - d
 - g
 - a
- Test 51**
- software
 - disk
 - directories
 - word processing
 - spreadsheet
 - desktop publishing
 - database
 - laptop, palmtop
 - help
 - drive
 - modem
 - internet
- Test 52**
- c
 - f
 - n
 - g
 - j
 - m
 - e
 - k
 - d
 - b
 - a
 - h
 - l
 - i
- Test 53**
- 3
 - 8
 - 7
 - 7
 - 5
 - 2
 - h
 - i
 - j
 - k
 - l
 - m

Word list

The numbers after entries are the tests in which they appear.

- A**
 about 20
 acceptable 22
 accounting 29
 accounts 47
 accurate 23
 action 28
 adaptable 22
 adapter 17
 addressee's name and address 43
 advertise 49
 advertisement 31
 advertising 29, 31
 after-sales 47
 after-sales service 57
 agency 49
 agenda 36, 40, 41
 agreement 38
 aim 28
 aisle 18
 alternative 28
 ambitious 21
 analysis 30, 38
 annual general meeting (AGM) 37, 58
 annual report 40, 41
 any other business (AOB) 36
 apology 44
 applicable 27
 appoint 6
 appointment 9
 appraisal 21, 50
 appraisal interview 21
 approximately 20
 argument 38
 around 20
 arrange a meeting 27
 assembly line 52
 assistant 28
 as soon as possible (ASAP) 58
 audit 54
- B**
 bad news 44
 badge 9
 bar graph 42
 based in 1
 battery 54
 benefits 5
 bill 18
 blue-collar 31
 blue-collar worker 12
 board 47
 bonus 5, 50
 boss 4
 bottom 35
- C**
 call 28
 call a meeting 27
 call centre 10
 campaign 49
 car 5
 care 60
 career 6
 careful 22
 cash 17
 cash flow 48
 catering services 57
 cautious 21, 22
 CD-ROM 7
 centre 35
 chair 36
 chairman of the board 13
 check-in desk 18
 chequebook 17
 chief 24
 chief accountant 11
 chief executive officer (CEO) 4, 13, 24, 58
 choice, 28
 cleaning 57
 clerical grade 12
 clever 22
 client 24, 28
 closed 36
 closing 45
 coin 17
 colleague 4
 come home 3
 commercials 49
 communications 29, 47
 company 2, 24, 28, 45, 59
 compensation and benefits manager 13
 competitive 27
 competitor 2, 60
 complaint 59
 complete 59
 complimentary close 43
 computer 29
- D**
 database 51
 date 44, 45
 date of birth 45, 46
 day-care centre 50
 days off 55
 deadline 59
 deal 9, 27, 59
 deal with 59
 decide 27
 decision 36, 38
 decision-maker 30
 decision-making meeting 37
 decrease slowly 39
 deliver 24
 demand for 1
 demanding 21
 department 28
 dependable 22
 depend on 1
 deputy 13, 28
 desk 28
 desktop publishing 51
 diagram 42
 diplomatic 23
 director 4
 director of finance 13
 director of human resources 13
 director of marketing 13
 director of operations 13
 director of research and development 11, 13
 directory 41, 51
 disagreement 38
 discuss 3, 28, 59
 discussion 38
 discussion meeting 37
 disk 7, 51
 disk drive 7

Test 54

- 1 batteries
- 2 recycle
- 3 waste
- 4 plastic
- 5 scrap
- 6 photocopies
- 7 bulbs
- 8 packaging
- 9 audit
- 10 suggestions
- 11 green

Test 55

- 1 h
- 2 f
- 3 c
- 4 d
- 5 a
- 6 g
- 7 j
- 8 e
- 9 i
- 10 b
- 6 c
- 7 e
- 8 b
- 9 a
- 10 h

Test 56

- 1 d
- 2 i
- 3 f
- 4 j
- 5 g
- 6 j
- 7 b
- 8 d
- 9 c
- 10 c

Test 57

- 1 h
- 2 g
- 3 a
- 4 i
- 5 f
- 6 j
- 7 b
- 8 d
- 9 c
- 10 c

Test 58

- 1 for your information
- 2 Chief Executive Officer
- 3 Vice President
- 4 Human Resources
- 5 Research and Development
- 6 Annual General Meeting
- 7 as soon as possible
- 8 Value Added Tax
- 9 not available
- 10 Personal Assistant
- 11 Okay? Alright?

Test 59

- 1 f
- 2 a
- 3 h
- 4 k
- 5 d
- 6 i
- 7 b
- 8 g
- 9 j
- 10 c
- 11 e

- a set up → run → sell off a company
- b fix → postpone → hold a meeting
- c hire → keep → fire staff
- d research → test → launch a new product
- e prepare → practise → give a presentation
- f start up → manage → complete a project
- g build → lead → break up a team
- h identify → discuss → solve a problem
- i set → work to → meet a deadline
- j receive → deal with → resolve a complaint
- k propose → negotiate → sign a deal

Test 60

- 1 employees
- 2 competitors
- 3 talking
- 4 quality
- 5 care
- 6 experience
- 7 flexible
- 8 invest
- 9 empowered
- 10 goal

distribution 14, 47, 57
 distributor 53
 division 28
 documentation 44
 dotcom 20
 drive 51
 dynamic 21

E
 easy-going 22
 e-commerce 20
 economic 31
 economical 31
 education 46
 efficient 21, 23
 elevator 60
 e-mail 20, 33
 employee 2, 28, 60
 employee relations 50
 employment law 50
 empowered 60
 enclosure 43
 enterprise 28
 envelope 8
 equal opportunities 50, 55
 equal pay 55
 excellent 22
 excess baggage 18
 exchange rate 56
 executive 24, 25, 28
 expenditure 31
 expenses 5, 31
 experience 46, 60
 experienced 23
 export 28
 extension number 45
 external communications 1, 14

F
 face to face 33
 factory 10, 15, 24, 28
 factory manager 13
 fall rapidly 39
 family company 16
 fax 33, 41
 fifty-five 20
 file 8
 filing cabinet 8
 final paragraph 43
 finance 14, 47
 finance director 11
 financial 25, 29
 finished goods 14
 fire 6, 26, 59
 fire extinguisher 52
 firm 24, 28
 first name 45
 fix 3, 27, 59
 flat organization 12
 flexible 22, 60
 flexitime 55
 floor 9

flow chart 42
 fluctuate 39
 folder 51
 forecast 27, 48
 foreigner 31
 forklift truck 52
 for your information (FYI) 58
 friendly 22, 23

G
 give 59
 glass ceiling 55
 go 3
 go down steadily 39
 go up steadily 39
 goal 60
 good news 44
 goods 24
 green 56
 greeting 44
 growth rate 56

H
 half seven 20
 hand luggage 18
 hanging file 8
 hard disk 7
 hard hat 52
 have 3
 head 25
 headed paper 8
 headhunter 50
 head office 15, 24
 headquarters 15, 24
 health and safety 50
 health insurance 5
 help 51
 hierarchical 12
 hire 59
 hold 59
 hole punch 8
 homeworking 55
 honest 23
 hostile takeover 16
 human resources (HR) 24, 47, 58
 human resources director 11

I
 identify 59
 identity card 9
 in 53
 income 5, 28
 increase dramatically 39
 inform 30
 informant 30
 information about 1
 information meeting 37
 information on 1
 information technology (IT) 14, 47
 in-house magazine 35, 41
 intelligent 22
 interested in 1

internal communications 1
 internet 20, 51
 interruption 38
 interviewee 31
 interviewer 31
 in-tray 33
 introductory paragraph 43
 invest 60
 investment 48
 investor 4, 30
 invoice 40, 41
 invoicing 48
 item 36

J
 job 6
 job interview 21
 job sharing 55
 job title 45
 join 6
 joint venture 16
 junior management 12

K
 keep 59
 keyboard 7
 key 17

L
 languages spoken 46
 laptop 20, 51
 launch 27, 49, 59
 layer 12
 lead 59
 leader 2, 4
 leave school 6
 left-hand side 35
 legal 47
 leisure interests 46
 letter 24, 35, 40, 41
 letterhead 43
 level 12
 level out 39
 lift 9
 line 31
 line graph 42
 local agent 15
 local office 15
 look at 3
 loss 49
 loudspeaker 7

M
 machine 52
 machine guard 52
 mail services 57
 mailshot 40, 41
 main building 9
 main gate 9
 main paragraph 43
 make 3, 27, 28
 make redundant 6
 manage 30, 59

management 25
 manager 4, 24, 28
 managerial 27
 managing director 11, 24
 manufacture 28
 manufacturer 53
 manufacturing 24
 manufacturing sector 56
 map 42
 margins 49
 marital status 43
 market 25, 28, 29
 marketing 14, 47
 marketing director 11
 maternity leave 55
 matters arising 36
 meet 3, 59
 meeting 33, 36, 38, 59
 meeting room 10
 meeting to maintain contact 37
 memo 40, 41
 merger 16
 middle management 12
 mind map 25
 minutes 36, 40, 41
 mixed economy 56
 mobile phone 17, 20
 modem 51
 monitor 7
 monthly 36
 mouse 7
 move 6

N
 name 46
 nationality 46
 national sales manager 13
 neat 22
 negotiate 3, 59
 negotiation 37
 nervous 21
 new product 59
 newsletter 40, 41
 not available (n/a) 58
 note 17
 notice board 33
 nought: point nought three 19
 number cruncher 20
 nursery 50

O
 obedient 23
 objective 24, 28
 offer 6
 office 9, 10, 15, 28
 office gossip 33
 OK 58
 one quarter 20
 open-plan office 10
 opposite number 4

option 28
 order form 40, 41
 organigram 42
 organize a meeting 27
 organizational 30
 organized 23
 orthodox 23
 outstanding 22
 over budget 49
 overalls 52
 overheads 48
 owner 4

P
 packaging 49, 54
 packer 52
 pager 20
 palmtop 20, 51
 paper clip 8
 parent company 16
 parts 14
 passport 17
 patient 21, 23
 pay 24, 28, 50
 payroll administration 57
 pension 5
 people 49
 personal 31
 Personal Assistant 58
 personnel 14, 24, 28, 31
 persuade 30
 persuader 30
 phone 28, 33
 photocopy 54
 physical evidence 49
 pic chart 42
 place 49
 place of birth 45
 plan 24, 28, 42
 planning 38
 planning meeting 37
 plant 15, 24, 28
 plastic 54
 plastic sleeve 8
 play 27
 point 36
 position 24
 post 24
 postcode 45
 Post-it 8
 postpone 59
 practise 59
 predictable 23
 preparation 38
 prepare 59
 present 3
 presentation 38, 59
 price 25, 49
 price list 41
 principal shareholder 16
 printer 7
 privatized 16

problem 59
 problem-solving meeting 37
 process 49
 produce 28
 product 2, 24, 25, 28, 49
 production 24, 27, 29, 30, 31, 47
 production and distribution 14
 production manager 11
 productivity 31
 profit 2, 25, 28, 48
 project 59
 promote 6
 promotion 49
 proposal 38
 propose 59
 public relations 14
 public relations manager 11
 punctual 21
 purchaser 24
 purchasing 47
 purchasing manager 11

Q
 qualification 46
 quality 14, 29, 60
 questionnaire 49

R
 raise 27
 raising 31
 rate of income tax 56
 rate of inflation 56
 re 44
 reach 27, 28
 reach a low point 39
 reach a peak 39
 read 3
 receive 59
 reception 10, 14
 reception desk 9
 receptionist 9
 recession 56
 recruitment 50
 recycle 54
 regional headquarters 15
 regional sales manager 13
 regulatory 30
 relaxed 21, 22
 reliable 21, 22, 23
 report 38
 request 45
 research 14, 28, 29, 49, 59
 research and development (R&D) 47, 58
 research and development centre 15
 research lab 10
 reservation 18
 resolve 59
 responsibility 46
 responsible 23

WORD LIST

- responsible for 1
 retail outlet 53
 retire 6
 returner 55
 tight-hand side 35
 ring 28
 ring binder 8
 rise 5
 rise slightly 39
 rising 31
 robot 52
 room 36
 room service 18
 roughly 20
 ruler 8
 run 59
- S**
- safety notice 52
 salary 5, 24, 28, 31
 sales 29, 47
 sales brochure 41
 sales director 11
 sales report 40, 41
 sales revenue 24
 salutation 43
 satisfactory 22
 scanner 7
 schedule 28
 scheme 24
 scissors 8
 scrap 54
 screen 7
 seat belt 18
 secretary 9, 11
 section 28
 secure 23
 security 57
 security guard 9
 self-assured 22
 self-confident 21, 22
 sell 28, 53
 sell off 59
 semi-skilled grade 12
 sender's address 43
 sender's name 43
 sender's title 43
 senior management 12
 sensitive 23
 service sector 56
 set 59
 set up 59
 seven thirty 20
 share 2
 shareholder 2, 4
 share price 2, 39, 47
 shelving 52
 shop-floor worker 52
 showroom 10
- shy 21, 22
 sign 9, 59
 signature 43, 44
 sincere 23
 single 18
 skilled grade 12
 software 51
 solution 38
 solve 27, 59
 spreadsheet 51
 staff 25, 28, 31, 59
 stakeholder 16
 stapler 8
 staples 8
 start 6, 36
 starting 44
 start up 59
 state-owned 16
 stock option 5
 storage 57
 stranger 31
 subordinate 4, 28
 subsidiary 2, 16
 subsidy 48
 suggestion 38, 54
 summary 38
 superior 4
 supervisor 52
 supervisory grade 12
 supplier 4
 supply 24
 supply chain 14
 surname 43
 switchboard 14
 systematic 22, 23
- T**
- table 42
 take 3
 takeover 16
 talking 60
 target 25, 28
 team 59
 telephone after-sales 14
 test 59
 three double four oh four five
 six two 20
 three-quarters 20
 through 53
 ticket 17
 tidy 21, 22, 23
 timetable 28
 timid 22
 tip 18
 tolerant 23
 top 35
 track record 31
 trade fair 10
 trade union membership 56
- traditional 23
 training 47, 50, 57
 training and development
 manager 13
 training centre 10, 15
 transport 53
 travel 31
 tribunal 50
 trip 31
 troubleshooting meeting 37
 trustworthy 23
 turnover 2, 24
 twenty-fifth 20
 twenty-three hundred hours
 20
 two 20
 two thousand and two 20
- U**
- unemployment rate 56
 unique selling proposition
 (USP) 60
 unskilled grade 12
 user's guide 40
 user manual 41
- V**
- Value Added Tax (VAT) 58
 Vice President (VP) 58
 video conference 33
 voucher 5
- W**
- wage 31
 waiter 18
 wallet 17
 warehouse 10, 15, 53
 warm 22
 waste 54
 waste bin 52
 waste paper bin 8
 web camera 7
 website 20, 44
 white-collar 31
 white-collar worker 12
 with best wishes (wbw) 00
 word processing 51
 work for 1
 workforce 28, 40
 work in 1
 work on 1
 work telephone number 45
 work to 59
 working conditions 50
 works 28
 write 3
- Z**
- zero 20